

Basic MALARIA MICROSCOPY

Part I. Learner's guide

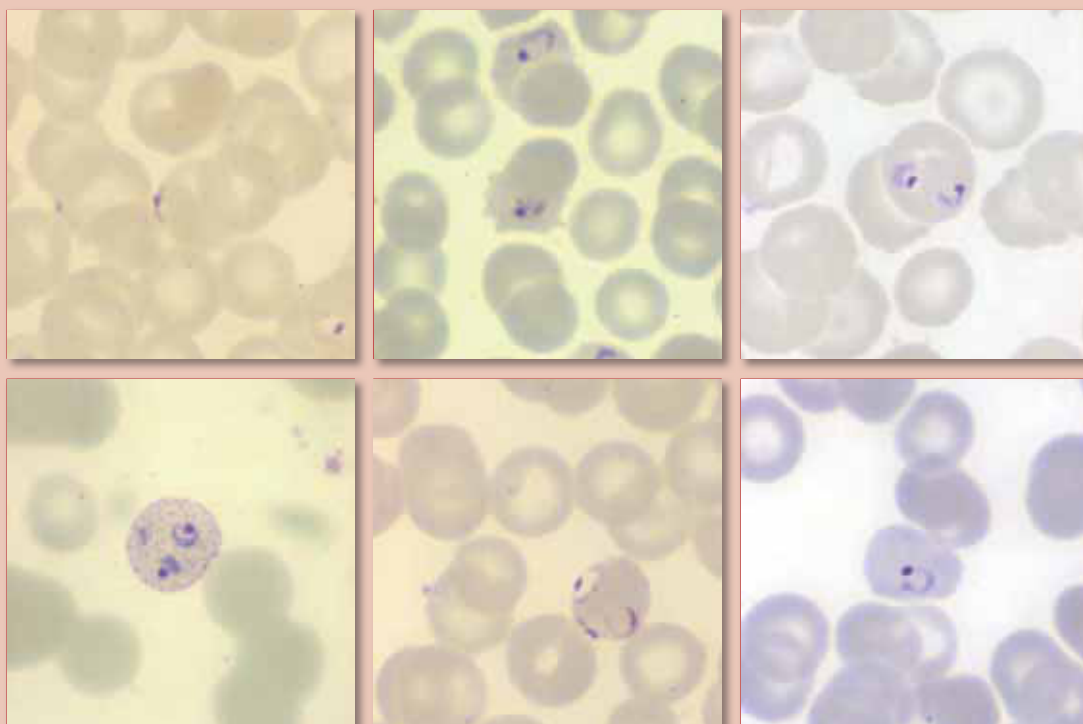

Second edition



World Health
Organization

This second edition of the *Basic Malaria Microscopy* package is a stand-alone product, providing all that is needed to conduct a complete training course. It has been compiled by John Storey on the basis of the feedback received from a wide range of professionals and experts who have been using the first Edition of the *Basic Malaria Microscopy*, published by WHO in 1991. It still contains the beautiful and accurate water-colour illustrations prepared for the first edition of the manual by the late *Yap Loy Fong*. Experience has shown that colour drawings are best in training new recruits to recognize parasite stages and species, because single plane pictures help students to extrapolate from what they see under the microscope, focussed at a number of focal planes, to a complete view of the parasite. Later, they can move from drawings and use microphotographs, which will have an additional, positive impact. The training course is further strengthened if copies of the WHO *Bench aids for malaria microscopy* are also made available to trainees.

Front cover, inserts: photomicrographs of Giemsa stained thin films showing clockwise from top left: early trophozoites (ring stages) of 1) *Plasmodium falciparum*, 2) *Plasmodium vivax*, 3) *Plasmodium malariae* and 4) *Plasmodium ovale*; and mature trophozoites of 5) *Plasmodium falciparum* and 6) *Plasmodium vivax*.

Basic **MALARIA** **MICROSCOPY**

Part I. Learner's guide

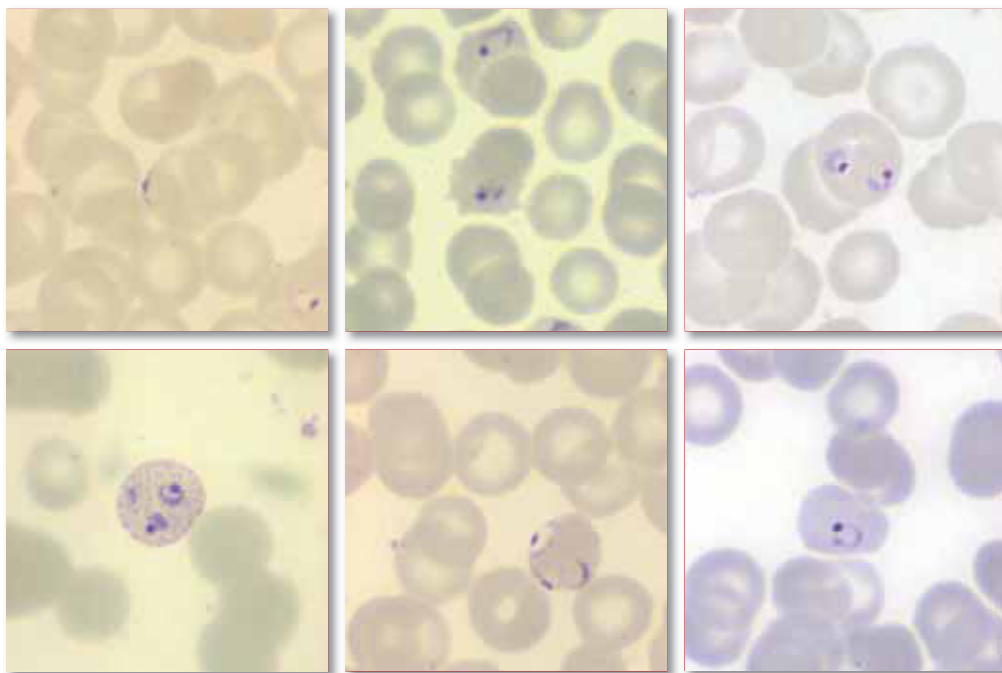

Second edition

WHO Library Cataloguing-in-Publication Data

Basic malaria microscopy – 2nd edition.

Contents: - Part 1: Learner's guide - Part 2: Tutor's guide.

1.Malaria - laboratory manuals. 2.Malaria - diagnosis. 3.Microscopy - laboratory manuals. 4.Teaching materials.

ISBN 978 92 4 154782 6 (Part 1)

(NLM Classification: W 25)

© World Health Organization 2010

All rights reserved. Publications of the World Health Organization can be obtained from WHO Press, World Health Organization, 20 Avenue Appia, 1211 Geneva 27, Switzerland (tel.: +41 22 791 3264; fax: +41 22 791 4857; e-mail: bookorders@who.int). Requests for permission to reproduce or translate WHO publications – whether for sale or for noncommercial distribution – should be addressed to WHO Press, at the above address (fax: +41 22 791 4806; e-mail: permissions@who.int).

The designations employed and the presentation of the material in this publication do not imply the expression of any opinion whatsoever on the part of the World Health Organization concerning the legal status of any country, territory, city or area or of its authorities, or concerning the delimitation of its frontiers or boundaries. Dotted lines on maps represent approximate border lines for which there may not yet be full agreement.

The mention of specific companies or of certain manufacturers' products does not imply that they are endorsed or recommended by the World Health Organization in preference to others of a similar nature that are not mentioned. Errors and omissions excepted, the names of proprietary products are distinguished by initial capital letters.

All reasonable precautions have been taken by the World Health Organization to verify the information contained in this publication. However, the published material is being distributed without warranty of any kind, either expressed or implied. The responsibility for the interpretation and use of the material lies with the reader. In no event shall the World Health Organization be liable for damages arising from its use.

Design and layout by WHO Graphics
Printed in Switzerland

Contents

Preface	1
Introduction	3
<hr/>	
Learning unit 1	
Malaria, the disease	7
<hr/>	
Learning unit 2	
Cleaning and storing microscope slides	13
<hr/>	
Learning unit 3	
Keeping records	19
<hr/>	
Learning unit 4	
Preparing blood films	21
<hr/>	
Learning unit 5	
Staining with Giemsa stain	29
<hr/>	
Learning unit 6	
The microscope	37
<hr/>	
Learning unit 7	
Examining blood films	45
<hr/>	
Learning unit 8	
Examining blood films for malaria parasites	51
<hr/>	
Learning unit 9	
Routine slide examination	69
<hr/>	
Learning unit 10	
Supervision in malaria microscopy	77



Preface to the second edition

An informal WHO consultation on quality assurance for malaria microscopy, held in Kuala Lumpur, Malaysia, in 2004 recommended that the 1991 edition of WHO's *Basic malaria microscopy*¹ be revised. This second edition is the result of that recommendation.

Few real changes in the microscopy of malaria parasites have occurred since 1991, but much has changed in the way malaria is diagnosed and treated. There is better understanding in remote communities that malaria is a medical emergency and requires rapid diagnosis and treatment. As part of efforts in many countries to expand access to treatment, microscopy services are being renewed and upgraded. Parasitological confirmation of a diagnosis of malaria will strengthen the surveillance of malaria and improve control of the disease.

Microscopists are vital to malaria programmes, and their diagnostic and technical skills are relied on in both curative services and disease surveillance. Thus, training in malaria microscopy must be sound and must reach today's high standards. When microscopists are trained and able to make quality-assured diagnoses of malaria, communities at risk have greater confidence in their services, and both patients and prescribers benefit.

The training package presented here has been adjusted to meet the changed conditions. The training manual is divided in two parts: a learner's guide (Part I) and a tutor's guide (Part II). The package includes a CD-ROM, prepared by the United States Centers for Disease Control and Prevention, which contains microphotographs of the different malaria parasite species and technical information in PowerPoint format, which can be shown during training sessions and referred to by the participants. Emphasis is placed on teaching and learning, including monitoring and evaluating individuals and the group during training.

The Basic Malaria Microscopy programme continues to use the 'competence-based' concept of achieving set targets of competence. Attempts have been made to indicate the appropriate standards that will qualify a participant for graduation and for progress between learning units. The levels of competence to be attained at the end of this training course are the minimum levels defined in the WHO *Malaria microscopy quality assurance manual*². For example, "Reaching 80% accuracy in diagnosing malaria parasites" (assessed against a standard set of microscopy slides) is considered achievable by every participant. It is recognized, however, that some programmes may not yet be able to reach such standards and initially must set their own. The course organizers should indicate the standards they expect train-

1 WHO. *Basic malaria microscopy: Part I Learner's guide; Part II Tutor's guide*. Geneva, World Health Organization, 1991

2 WHO. *Malaria microscopy quality assurance manual*. Manila, Western Pacific Regional Office, 2009.

ees to reach. As the trainees, once they have graduated, will be making decisions that determine the management of a potentially fatal disease, a high standard of competence must be ensured.

This second edition of the Basic Malaria Microscopy package is a 'stand-alone product', providing all that is needed to conduct a complete training course. It still contains the beautiful and accurate water-colour illustrations prepared for the first edition of the manual by the late Yap Loy Fong. Experience has shown that colour drawings are best in training new recruits to recognize parasite stages and species, because 'single plane' pictures help students to extrapolate from what they see under the microscope, focussed at a number of focal planes, to a 'complete view' of the parasite. Later, they can move from drawings and use microphotographs, which will have an additional, positive impact. Thus, the training course is further strengthened if copies of the *Bench aids for malaria microscopy*¹ are also made available to trainees.

The text for this edition was extensively revised by John Storey, on the basis of reviews by Professor Ahmed A. Abdel-Hameed Adeel, Dr Hoda Atta, Dr A. Beljaev, Dr David Bell, Dr Andrea Bosman, Ms Leigh Dini, Dr John Freat, Dr M.A. Khalifa, Dr D. Klarkowski, Dr Ken Lilley, Dr Earl Long, Dr Majed Al Zedjali and Dr R. Velayudhan. In addition, Donato Esparar, Ronald Espina, Sherwin Galit, Zenaida Grad, Felisa Guballa, John Fiel Porto and Arlene Leah Santiago tested and made valuable comments on the new keys to thick and thin films in the Learner's guide.

This project was coordinated for the WHO Global Malaria Programme by the WHO Western Pacific Regional Office and received financial support from AuAid and the Russian Federation, for which grateful acknowledgement is made.

1 WHO. *Bench aids for malaria microscopy*. Geneva, World Health Organization, 2009.

Introduction

The Learner's guide

This handbook (Part I of the Basic Malaria Microscopy training modules) will assist participants during training in the microscopic diagnosis of human malaria. Designed as the foundation for formal training of 4–5 weeks' duration, the guide is destined for participants with only elementary knowledge of science.

On completing the training, these personnel will be responsible for diagnosing malaria in blood films from suspected cases in their communities, and important treatment decisions will be based on their competence in ensuring unsupervised diagnosis of malaria. In order to gain the confidence of the public and the health system, the quality of training of these personnel must be of the highest possible standard and demonstrated to be so.

The course has a 'competence-based' structure, in which the essential technical information for the acquisition of skills and 'how to' instructions are given in an easily understood format. The training is mostly 'hands-on'. By the end of the course, the trainees must be demonstrated to have acquired a high level of competence. Competence-based training is a powerful, well-tested way of acquiring skills essential for public health services and health care.

In addition to training health workers in basic malaria microscopy, the modules can be used for refresher training for established staff conducting standard Giemsa-based malaria microscopy. As these personnel will already have a firm background and work experience, they should be able to reach the course objectives within 11–12 working days. District and provincial hospital laboratory technicians familiar with the laboratory procedures could benefit from a shortened course; although malaria microscopy is part of their daily routine, refresher training courses are beneficial to ensure accuracy.

The guide is divided into learning units. The notes and instructions in each unit are sufficient to minimize extensive note-taking by the participants so that they can participate fully in presentations and discussions. A page for notes is provided at the end of each unit.

Standard operating procedures are outlined and followed when appropriate, so that, once training is completed, the guide will continue to be a reference. This is particularly useful for people working in isolated areas, where high standards must still be ensured.

Before moving from one learning unit to the next, trainees must reach a designated level of competence in each identified skill. Failure to do so indicates that a person's skills are insufficient, and the training must be repeated until mastery is demonstrated.

Note: Levels of accuracy are based on minimum grades of competence, as defined in the WHO manual for malaria microscopy quality assurance.¹ The levels are usually set at 80–95%. For example, a microscopist working at peripheral level should be able to detect the presence of a parasite accurately in 90% of slides (after review of a standard set of slides for accreditation) and to identify the species of plasmodium accurately in 80% of slides. These figures may appear too high to some and too low to others; the levels will be decided by the course organizers. When a patient's life is at risk, the highest level of accuracy must be achieved. With this kind of training and the amount of practice time provided, participants should be able to reach the level of accuracy selected for the course. This approach keeps errors in microscopy to the lowest possible level and helps reduce severe malaria morbidity and mortality in communities.

**Competence-based training is well described
by the last line of the Chinese proverb below.
Facilitators and trainees follow this
strategy throughout the course.**

**Hear and forget.
See and remember.
Do and understand.**

Course objectives

Overall objectives

The overall objectives describe broadly what the learner will be able to do by the end of training. Participants will be able to:

- organize and run a small malaria microscopy laboratory; and
- accurately diagnose, with Giemsa microscopy and internationally recognized standard operating procedures, malaria infections in patients.

Specific objectives

The specific objectives cover the knowledge, skills and attitudes that participants will acquire and their ability to use them. They also illustrate the step-wise approach used for achieving each objective. Participants should be aware of what is expected of them from the very beginning of training.

After completing training, trainees will have successfully acquired the skills and competence to:

- describe the importance of malaria as a potentially life-threatening disease, in which early, accurate diagnosis and treatment are essential for patient recovery and survival;
- describe four common clinical signs and symptoms of malaria in patients;
- record on the correct laboratory or survey forms relevant patient details for subsequent information and patient follow-up;
- demonstrate their ability to prepare slides for blood filming correctly;

¹ WHO. Malaria microscopy quality assurance manual. Manila, Western Pacific Regional Office, 2009.

- adequately prepare a set number of thick and thin blood films;
- demonstrate the correct practice and precautions for preventing transmission of bloodborne pathogens when handling blood;
- demonstrate the correct Giemsa staining procedures for staining thick and thin blood films for malaria microscopy;
- demonstrate and describe the methods used to maintain microscopes in working order;
- demonstrate and use the correct procedures for examining stained thick and thin blood films for malaria parasites;
- demonstrate their ability to identify correctly the components of normal blood;
- recognize and identify malaria parasites present in blood films; identify the stage(s) of plasmodia, the presence of individual species or mixed infections of *Plasmodium falciparum*, *P. vivax*, *P. malariae* and *P. ovale*; and establish the density of malaria parasites in the film;
- record the results of the microscopy examination on the correct form;
- inform those responsible of the findings in a timely manner;
- demonstrate their understanding of the requirement to observe patient confidentiality and ethical issues;
- follow the correct procedures of the national programme, submit reports, stores slides for audits and prepare requests for supplies, to ensure the smooth functioning of the microscopy facility;
- use the handbook as a resource to teach health workers how to make thick and thin blood films, as part of the transfer of skills and team development; and
- organize, following the policies and requirements of the national malaria control programme, the collaboration necessary for regular supervision of the work of the laboratory.

Note: Any mention of 'stain' in the text refers to Giemsa stain, unless otherwise stated.

The training programme

A course tutor carries out the training, assisted by a team of facilitators. The class is divided into small groups consisting of three to five participants each, and one facilitator is assigned to each group. Using the *Learner's guide*, participants are guided through each unit. The facilitator ensures that each trainee receives appropriate guidance and reaches the required levels. Thus, learners receive individual attention from an experienced facilitator, who monitors their progress to ensure that each has reached the required standard before proceeding to the next unit and gives additional tuition when required.

The lessons consist of 15–20-min presentations followed by activities such as demonstrations, small group discussions and role-play. Most of the training consists of practical sessions. Regular practice helps learners to acquire the skills and knowledge needed for efficient Giemsa malaria microscopy. The timetable provides for as

much practice as possible, to help trainees gain practical experience in all aspects of malaria microscopy. Fieldwork is part of practice, and an additional objective is to provide the interpersonal experience of working with suspected malaria patients in a real-life setting. This can reveal other problems that can arise in everyday situations.

Formal evaluations are conducted regularly to assess achievement and provide information at an individual and a collective level.

Evaluation of the learner: These evaluations can include multiple-choice questions, spot tests, participant presentations and examination of 'known slides'. The latter is a regular exercise as learners progress through training and helps facilitators to gauge individual achievement. It is useful for identifying areas in which a learner has problems, giving an opportunity to address and correct those problems.

Evaluation of the training by the learner: By means of a questionnaire, the tutor asks the learners how they think the training has helped them and how it might be improved. These regular evaluation sessions also allow participants to comment on the teaching, the teaching standards, the quality of materials used and other conditions of training. Trainees make their comments anonymously, allowing beneficial modifications.

The tutor and facilitators will introduce you to the course and the materials to be used, including this handbook. Should you have difficulty during any part of the training, do not hesitate to contact your facilitator for further help.

**Please read Learning unit 1 in preparation
for the start of the course.**

Learning unit 1

Malaria, the disease

Learning objectives

By the end of this unit, you will be able to:

-
- **describe** why malaria is an important public health problem in many parts of the world;
 - **describe** four common symptoms of malaria;
 - **describe** why some people have malaria parasites in their blood but have no clinical symptoms;
 - **explain** how malaria parasites produce disease in people;
 - **explain** how some species of female *Anopheles* mosquito transmit malaria; and
 - **explain** why accurate diagnosis of malaria depends on correct microscopic identification.
-

The importance of malaria

Malaria is a serious public health problem in many parts of the world. Attacks of the disease can be severe and can lead quickly to death if untreated. Communities with high levels of malaria have many chronically ill members, resulting in absenteeism from work and school. Repeated attacks not only result in heavy spending on treatment but also affect education, the amount of food the family can grow and the money a family earns. Malaria is a serious risk to pregnant women and infants and is a common cause of miscarriage. In areas of high transmission, malaria is responsible for underweight infants at birth and anaemia in the mother (first pregnancies are particularly at risk). Lack of knowledge about malaria, poverty and chronic disease together form a vicious circle, which is difficult to break.

Malaria is caused by a small living organism, called a parasite, which infects a person's red blood cells. It is transmitted from one person to another by the bite of female *Anopheles* mosquitoes. The parasite must go through a complex cycle in both the mosquito and in humans before transmission can take place. In the mosquito vector, the cycle lasts for 1–3 weeks, depending on a number of factors, such as the malaria parasite species, the ambient temperature and the relative humidity.

In the past few years, attempts have been made to control the disease through the use of insecticide-treated nets, prompt diagnosis and appropriate treatment. These have resulted in significant reductions in mortality and morbidity in some countries. In other places, the disease continues to be the primary cause of illness and deaths.

Clinical signs and symptoms of malaria

The disease is reasonably easy to recognize in people who have not had malaria before, or have had few attacks. The common symptoms of malaria are: high fever, headache, severe chills or rigor, profuse sweating and general body pains. Some patients may have vomiting, cough or diarrhoea. In persistent and recurrent infections, anaemia may be present.

As similar clinical signs are seen in other common diseases, further investigations are necessary before a reliable diagnosis of malaria can be made. The clinical presentation of malaria is even less clear in patients who have had a number of malaria attacks, as they generally show no clear signs or symptoms. Care must also be taken to establish whether the patient has taken antimalarial medicines before going to hospital, as this can modify the clinical presentation. Previous treatment with antimalarial medicines, by reducing the parasite density to very low levels, may make microscopic diagnosis more difficult. Knowing which treatment was received is important in order to avoid an overdose of antimalarial medicines, which can be dangerous, especially if the patient was unconscious when admitted to hospital.

Diagnosing malaria: What is the best way?

In most village, district and provincial malaria laboratories, the most reliable method for diagnosing malaria is microscopic examination of a patient's stained blood film by a trained microscopist. 'Malaria microscopy' is a skilled exercise requiring great care at each step of the standard operating procedures and precise visual and differential skills.

Note: Your tutor or facilitator will explain the meanings of 'visual' and 'differential skills' and other words in this text that may not be familiar. Most will be easy to understand after such explanations.

Malaria is caused by a parasite in the blood; the parasites are very small (microscopic) and can be seen only under a microscope with high magnification. Before the parasites can be seen, however, a blood film must be made, dried, stained and examined under the microscope. When the microscopist sees stained parasites, the diagnosis of malaria is confirmed. Microscopists who use the skills learnt during this training can identify the stages and species of malaria parasite and the density of the infection. Using this information, the physician or health-care worker can treat the patient with the most appropriate antimalarial agents, in the best possible way.

Suspected malaria is an emergency, and the person must see a health worker quickly. Examination of patients' blood films ensures a quick diagnosis and helps them receive the correct treatment early. Failure to do this can put patients at great risk.

When you read the descriptions of the different steps for malaria microscopy, they may seem very difficult to learn. This is not the case. Learning units 2–10, which follow, will, with your facilitator's help, take you through each step and establish the standards you need to do such work. By the time you have reached the end of unit 10, you will have achieved the important skills of malaria microscopy. In recognition of this, you will be awarded a certificate or accreditation of competence, depending on the policies of your country. This will be explained during the course.

A patient in whom malaria is wrongly diagnosed might not be further investigated. This may result in another serious illness being missed.

The malaria parasite life cycle

A description of the malaria parasite life cycle is included here for your interest and information, to show you how complex it is and how difficult it can be to control malaria (Figure 1). Unless instructed to do so by your facilitator, you need not memorize the various portions of the cycle, but you can refer to the text and the diagram at the end of this unit.

Malaria in the mosquito vector

The sexual cycle

The sexual cycle of malaria parasites begins when a particular species of female *Anopheles* mosquito feeds on an infected person. Male malaria parasites (microgametocytes) in the infected person's blood, sucked into the mosquito's stomach, produce four to eight flagella. Each *flagellum* separates from the parent body and swims through the coagulating blood in the mosquito's stomach; when it finds a female malaria parasite (*macrogametocyte*), it enters and fertilizes it. After fertilization, a zygote is formed, which travels to the wall of the mosquito's stomach, where it squeezes between the cells of the stomach wall, settles under the outer lining and encysts. In this *oocyst*, the malaria parasites multiply until the oocyst contains many thousands of new parasites. Eventually, the oocyst ruptures and releases the spindle-shaped *sporozoites*, which make their way to the mosquito's salivary glands. The time needed for completion of the parasite life cycle in the mosquito, that is, between the time the female mosquito ingests an infected blood meal and the time she can transmit malaria, varies according to the species and the ambient temperature and humidity, but is usually 7–21 days.

Malaria in humans

The phase in the liver

When the infected female *Anopheles* mosquito bites a human being, *sporozoites* are introduced with the saliva that the mosquito uses as an anticoagulant. This anticoagulant prevents the blood from clotting in the mosquito's very small, tube-

like proboscis or mouth parts. Once inside the human being, the sporozoites move quickly to the liver, where they try to invade liver cells.

In infected liver cells, a single parasite divides and generates many thousands of new parasites over 7–21 days. The enlarged liver cell, called a *liver schizont*, finally bursts, releasing thousands of *merozoites* into the bloodstream, which quickly adhere to and enter red blood cells. On entering a red blood cell, the malaria parasite starts to grow, using the contents of the cell as food, and becomes a *trophozoite*.

This brief description of what happens in the liver phase applies to two of the malaria parasite species that affect humans, *P. falciparum* and *P. malariae*. The other two species, *P. vivax* and *P. ovale*, have a slightly different cycle, as a number of the parasites that originally enter the liver cells do not immediately become liver schizonts but enter a kind of sleeping phase. Called hypnozoites, these dormant parasites are responsible for the relapses that occur at intervals after the first malaria attack.

The blood phase

The blood phase is the focus of this course, and you will be familiar with every aspect of it by the end of the training.

Right now, that is all you need to know about malaria parasites and their life cycle. Your tutor will describe other aspects of the subject as you progress through the course. The diagram below clearly shows the life cycle and transmission of the parasite. You will find out more about the appearance of malaria parasites in thin and thick blood films in learning units 7 and 8.

**For clarity, read the Introduction and Learning unit 1 again.
When you have done that, read Learning unit 2
in preparation for the next session.**

Figure 1. The malaria parasite life cycle

Figure reproduced, with minor amendments, from Bruce-Chwatt's essential malariology, London, Arnold, 1993, with the permission of H.M. Gilles and D.A. Warrell, eds.

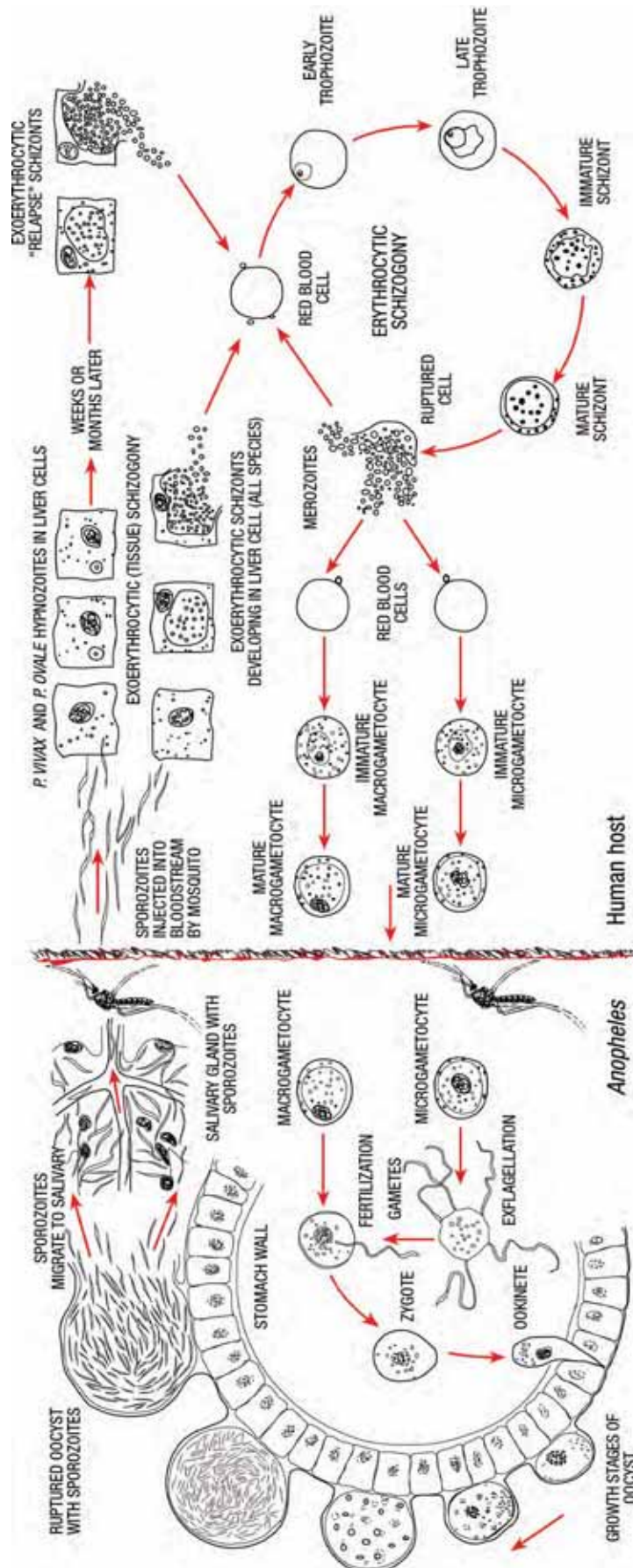

Notes

Learning unit 2

Cleaning and storing microscope slides

Learning objectives

By the end of this unit, you will be able to:

-
- **describe** one standard operating procedure and explain its importance for malaria microscopy;
 - **select** from previously used slides those suitable for making blood films and demonstrate why other slides are not suitable; and
 - **demonstrate** the two correct ways of washing, drying, wrapping and storing microscope slides for making blood films.
-

Working in a laboratory

If this is the first time you have worked in a laboratory, you may feel strange or nervous. *Don't worry*. Once you are familiar with the way laboratories function, you will feel as though you have worked in one all your life. Some simple rules to follow in the laboratory will help you settle in quickly:

Basic rules for the laboratory:

- Do not touch, open or smell bottles, jars and containers or chemicals unless you have been instructed to do so or unless you know what you are doing and **know what is in the bottle**.
 - Clean up when you have finished your work: do not leave dirty glassware or slides for others to wash.
 - Do not eat or drink in the laboratory: eat and drink in designated areas.
 - Do not smoke.
 - Use the correct precautions when handling biological specimens, chemicals and 'sharps', such as needles and lancets.
 - Take appropriate care when handling liquids that may be corrosive or acidic or have strong fumes.
 - Wear protective gloves when handling materials contaminated with or holding blood.
 - Discard contaminated materials into the designated receptacles; if you are not sure, **ask someone who will know**.
 - As soon as a job is finished, wash your hands with soap and water.
-

Standard operating procedures

Standard operating procedures are used widely by clinicians and in laboratories. They have been described as “a set of written instructions that document the correct way of carrying out a routine or repetitive activity”. This is a simplifistic definition, but the facilitator will explain how standard operating procedures apply to your work. Remember, as you proceed through each learning unit, that each activity follows a series of steps, and each step must be achieved to a designated standard or level. When the step is correctly followed and the standard reached, your work product (in this unit, cleaned and wrapped slides) will be satisfactory. Deviating from the instructions given in an established standard operating procedure will result in a product of poorer quality or reliability.

The basis of this training programme is observance of the recommended steps. In doing so, you will reach the target levels of competence that qualify you to practise malaria microscopy.

The first lesson to be learnt is that you must follow the instructions given by your facilitator, as she or he will be using standard operating procedures that result in reliable malaria microscopy.

Cleaning slides

Correct cleaning of slides is your first activity. Like most of the activities covered in the units, it is quite simple. Deviation from the procedures will give poor results.

Poorly cleaned slides result in substandard blood films, poor-quality staining and imprecise microscopy and diagnosis. This places patients at risk. To avoid this, ensure that slides are well selected and properly cleaned, wrapped and stored.

Slides for malaria microscopy

The glass slides used in microscopy, often called ‘micro-slides’, are usually supplied in boxes of 50 or 72. They may be described on the label as ‘washed’ or ‘pre-cleaned’.

For malaria microscopy, prefer plain glass slides of ‘superior’ quality, with ground edges and a frosted end. The frosted end should be used to label the slide. The glass used in ‘superior’ quality slides does not ‘fog’ or become opaque in tropical conditions. Poorer quality glass slides are cheaper but deteriorate quickly in a hot, humid climate; washing does not remove the opaque patches, and the slides are useless for precise microscopy. Although the slides are described as ‘washed’ or ‘pre-cleaned’, this does not mean that they can be used directly from the box. ***Micro-slides must be washed, dried and wrapped before being used for blood films.***

Slides that are slightly scratched and considered unsuitable for blood films can be handed over to other sections of the laboratory service for routine use.

Washing and preparing slides

Two ways of washing and preparing slides for blood films are described below. Your facilitator will take you through these steps, describing and demonstrating the two methods.

For hospital laboratories

In hospitals, patients usually come singly, and there is time to clean slides as they are needed. It is sufficient to open one box of new slides at a time.

You will need:

- one box of new 'superior' quality micro-slides;
- one medium-sized plastic bowl or basin;
- good-quality liquid or powder detergent;
- a washing cloth or soft sponge;
- clean, lint-free cotton cloths (the kind used to dry crockery or glassware);
- methyl alcohol¹;
- a wide-mouth jar with a screw-fitting top, to hold alcohol and slides; and
- a supply of clean water.

The method:

1. Separate new slides one from the other and soak in detergent solution for 4–8 h, conveniently overnight.
2. After soaking, clean each slide on both sides by rubbing the two surfaces in the washing cloth or sponge between the forefinger and thumb.
3. Rinse the slides individually in clean water to wash off the detergent.
4. Drain excess water from the slides, before placing them in the jar of alcohol with the lid firmly screwed on. Keep out of direct sunlight.
5. When required, remove a slide and dry it thoroughly with a clean, lint-free cotton cloth. Always handle slides by the edges.
6. The slide is ready for use; it does not need wrapping.

For national malaria control programmes

In such programmes, malaria microscopy activities vary from a microscopist working alone in a remote laboratory with few facilities, to large epidemiological surveys, studies to monitor drug resistance and other activities in the field. To ensure that staff have the correct materials, cleaned, wrapped slides, stains and other supplies are often prepared and provided from a central location. In some rural areas, however, laboratory staff must clean their own slides or even recycle them,

¹ Methanol (methyl alcohol) is highly toxic and flammable; it can cause blindness and even death if swallowed in any quantity. When not in use, it should be stored in a locked cupboard.

due to shortages of supplies.¹ In these situations, a good supply of slides is needed, which must be ready, cleaned and wrapped beforehand. This increases efficiency significantly, as it ensures the availability of the large number of slides required for activities far from the laboratory. Cleaning is best done in a small group.

You will need:

- new 'superior' quality micro-slides or recycled, used slides;
- two medium-sized plastic bowls or basins;
- good-quality liquid or powder detergent;
- a washing cloth or soft sponge;
- a supply of clean, lint-free cotton cloths (the kind used to dry crockery and glassware);
- a supply of clean water;
- sheets of clean paper cut to about 11 cm x 15 cm;
- empty slide boxes of the type in which new slides are supplied;
- rubber bands or clear adhesive tape; and
- a warm cupboard or a desiccator with activated silica gel.

The method:

1. Treat new slides in the same way as described above in steps 1–4, but then dry them (do not store them in alcohol).
2. Soak used, dirty slides in warm water and detergent for a minimum of 6–8 h.
3. After soaking, clean each slide individually by the method described in step 2 above, until all traces of the old blood film and immersion oil are removed. This may require more than one soaking, depending on the state of the slides; hence the second bowl.
4. When the slides are clean, rinse them in clean water to remove all traces of detergent.
5. Dry each slide with a cotton cloth. Chipped or scratched slides are unsuitable for haematology and should be discarded; they may be used for medical entomology.
6. Wrap the dried slides in packs of 10 in the pieces of paper. Turn down the ends of the wrapper and secure them with clear adhesive tape, and place the packs into the cardboard boxes, ready for use.
7. As each box holds about 10 of these packs, it is easy to calculate the number of slides available for use or dispatch.
8. Store boxed clean slides in either a small, warm cupboard or a desiccator to ensure that they remain dry until required. Slides stored at room temperature at high humidity will stick together after a few weeks and cannot be used unless they are rewashed and dried.
9. For quality control, label each box with the date of cleaning and the name of the person responsible for cleaning.

¹ Use of new slides is recommended, but many programmes are unable to afford them, and slides must be selected from recycled ones.

In warm, damp climates, fungus grows quickly on glass slides, microscope lenses and prisms. Unless this is prevented by storage in a dry environment, heavy fungal growth may make it impossible to use a simple slide or a more complex microscope. In either case, you will be unable to do your job effectively.

The facilitator will describe 'warm cupboards' and other ways of protecting glassware and microscopes from fungus.

Read Learning unit 3 in preparation for the next session.

Notes

Learning unit 3

Keeping accurate records

Learning objectives

By the end of this Learning unit, you will be able to:

-
- **identify** the correct record form(s) and register(s) for entering information on patients;
 - **demonstrate** preparation of accurate, error-free records on the appropriate form;
 - **select** the correct copy of each record form, or completed summary, for dispatch to the supervisor;
 - **describe** examples of the possible consequences of mixing up patients' records; and
 - **explain** why a patient's details are confidential and must not be shared with unauthorized persons.
-

It is important to ensure that patients' details can be traced easily by recording all appropriate information when they attend the clinic or when interviewed at home. Most information is stored in a computer databank and requires specially designed forms, which usually cover:

- the region, province, district or zone in which the work was done;
- the town, village or locality in which the patient lives;
- the street and house number at which the patient can be contacted;
- the patient's name, sex and age;
- the patient's number, which may also be the blood film number;
- other details, such as symptoms, body temperature and weight;
- the results of the blood film examination, such as positive or negative for malaria parasites, species and stages seen and whether *P. falciparum* gametocytes were observed;
- any antimalarial treatment received before microscopy examination; and
- other comments, observations or instructions to the clinician.

Even if you do not have a computer, the essential details must be recorded in a daily register. Your facilitator will provide examples of the forms currently in use and advise you how to complete them correctly. You will also practise completing them under normal working conditions in the laboratory or the field.



Remember:

A patient's details are confidential. It is unethical to discuss information in a patient's records with unauthorized persons. Patient records should be stored securely, safe from unauthorized access.

Read Learning unit 4 in preparation for the next session.

Notes

Learning unit 4

Preparing blood films

Learning objectives

By the end of this unit, you will be able to:

- **explain** why blood must always be regarded as potentially contaminated;
- **name** four diseases found in infected blood;
- **demonstrate** the normal precautions used when handling blood;
- **demonstrate** the action to take when blood contaminates something accidentally;
- **list** the materials required for making thick and thin blood films;
- **demonstrate** the correct method for preparing a thick and a thin blood film on the same slide, for malaria microscopy;*
- **demonstrate** the correct way of labelling a blood film;
- **separate** thick and thin blood films of acceptable quality from unacceptable ones, giving reasons for the selection; and
- **describe** and identify common mistakes and faults in making thick and thin blood films and the causes.

* A minimum of 80% of blood films must be prepared to a satisfactory standard or meet the satisfactory level decided for your course.

Accidental contamination with a patient's blood presents potential risks to health staff and patients for a number of diseases. The risks are kept to extremely low levels if the following precautions are taken:

- Wear protective gloves when taking blood samples or handling blood.
- Avoid getting blood, including dry blood from films, on your fingers or hands.
- Cover cuts or abrasions on your hands with a waterproof dressing.
- Avoid accidentally pricking yourself when handling sharp instruments that have been in contact with blood.
- Thoroughly wash your hands with soap and water as soon as you finish a job.
- If you get blood on your skin, quickly wipe it off with a cotton swab dampened with alcohol; then, wash the affected area with soap and water as soon as possible.

- Blood-contaminated materials such as lancets, broken slides and cotton swabs must be discarded in a 'sharps bin'. If a 'sharps bin' is not available, follow your programme's established practice and safely dispose of the materials by incineration.

Some people carry a disease in their blood even when they do not appear to be ill. Diseases in the blood are not easily detected, and the tests to demonstrate them are sometimes complicated and expensive.

Hepatitis, HIV/AIDS, malaria and syphilis are the commonest, but others, such as leptospirosis, may be seasonal and common in certain areas.

Ensure, when handling blood, that you practise the correct preventive measures.

Kinds of blood film

In malaria microscopy, two kinds of blood film are used: thick and thin.

The thick film

A thick film is always used to search for malaria parasites. The film consists of many layers of red and white blood cells. During staining, the haemoglobin in the red cells dissolves (dehaemoglobinization), so that large amounts of blood can be examined quickly and easily. Malaria parasites, when present, are more concentrated than in a thin film and are easier to see and identify.

The thin film

The thin film is used to confirm the malaria parasite species, when this cannot be done in the thick film. It is used to search for parasites only in exceptional situations. A well-prepared thin film consists of a single layer of red and white blood cells spread over less than half the slide. The frosted end of the slide is used for labelling. Use of the thin film as a label is no longer recommended. If slides with a frosted end are not available, then details can be written on the thin film with a soft lead pencil. Do not lick the end of the pencil during use.

Preparation of a thin and a thick blood film on the same slide

You will need:

- protective quality latex gloves without talcum powder (two to three pairs per person per exercise);
- cleaned, wrapped slides (more than are needed);
- sterile lancets (one per patient, plus 10%);

- 70% ethanol;
- absorbent cotton wool;
- a sharps container;
- a slide box or tray for drying slides horizontally and protecting them from flies and dust;
- four or five clean, lint-free cotton cloths;
- record forms or a register;
- ballpoint ink-pen for the record forms or register; and
- an HB lead pencil to write on the thin film and small sharpener.

The method:

After recording the patient's details on the form or register, wearing protective latex gloves, hold the patient's left hand, palm facing upwards, and select the third finger from the thumb, called the 'ring finger'. For infants, the big toe can be used, not the heel. Never use the thumb, for either children or adults.



Clean the finger with cotton wool dampened with alcohol. Use firm strokes to remove dirt and oils from the ball of the finger.

Dry the finger with a clean cotton cloth, using firm strokes to stimulate blood circulation.

Using a sterile lancet and a quick rolling action, puncture the ball of the finger or toe.



Apply gentle pressure to the finger or toe and express the first drop of blood; wipe it away with dry cotton wool, making sure that no cotton strands remain that might later be mixed with the blood.

Working quickly and handling the slides only by the edges, collect the blood as follows:

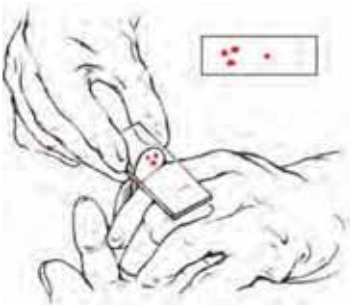

Apply gentle pressure to the finger and collect a single small drop of blood about this size ● on the middle of the slide. This is for the thin film.

Apply further gentle pressure to express more blood, and collect two or three larger drops on the slide, about 1 cm away from the drop intended for the thin film. Wipe the remaining blood off the finger with cotton wool.

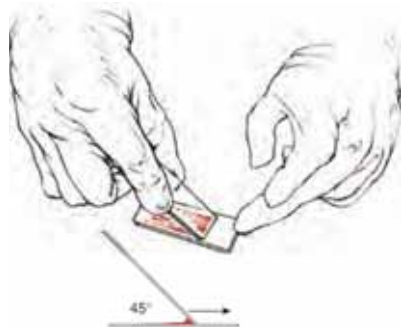

The thin film: Using another clean slide as a spreader and with the slide with the blood resting on a flat, firm surface, touch the small drop of blood with the edge of the spreader, allowing the blood to run right along the edge.

Firmly push the spreader along the slide, keeping it at an angle of 45°. The edge of the spreader must remain in even contact with the surface of the other slide while the blood is being spread.

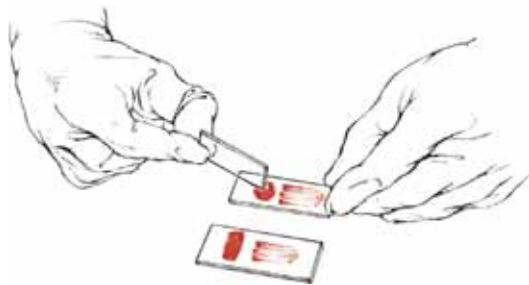

The thick film: Handling the slides by the edges or a corner, make the blood film by using the corner of the spreader to join the drops of blood, and spread them to make an even, thick film. Do not stir the blood. A circular or rectangular film can be made by three to six quick strokes with the corner of the spreader.

The circular thick film should be about 1 cm in diameter.

The thick film should be dried level and be protected from dust, flies, sunlight and extreme heat.



Under normal conditions, the thin film dries quickly. In the past, the patient's details, slide number and date used to be recorded with a soft lead pencil on the thicker part of the thin film. Preferably slides with a frosted end should be used and the frosted end used as the label. Using the thin film as a label is no longer recommended.

Avoid touching writing instruments to the blood film. Do not use a ballpoint or gel pen to label slides, as the ink will spread when the film is fixed.

When the thick film is completely dry, wrap the slide in the patient's record form and quickly forward it to the laboratory. Slides that are not to be processed immediately can be stored in a desiccator before staining

Slides that are correctly made leave little blood on the spreader. The spreader slide can be used for making thick and thin films from the next patient, while another clean slide from the pack is used as the fresh spreader.

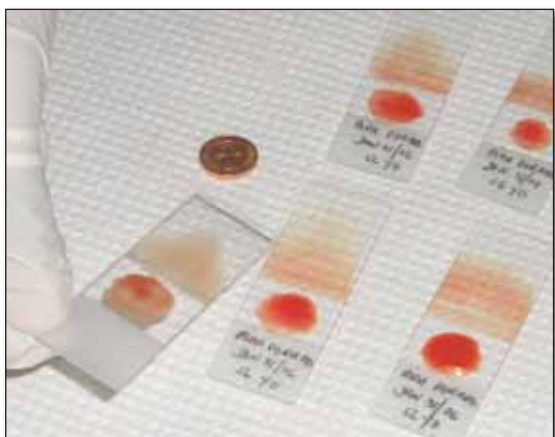

Common faults in preparing blood films

Faults commonly seen in blood films may affect the labelling, the staining or the examination itself and, therefore, the outcome for the patient.

Poorly positioned blood films

If films are not correctly sited on the slide, they may be impossible to examine. Parts of the thick film can be rubbed off by the edges of the staining trough, drying rack or slide frame.

This thin film is too large; the thick film is wrongly positioned and will be difficult to examine under the oil immersion objective.



Too much blood

Stained thick films made with too much blood will have a very blue background. There will be too many white blood cells per field, which may obscure any parasites that are present. In thin films that are too thick, the red cells will be on top of one another, making it impossible to see parasites clearly.



Too little blood

When there is too little blood in the films, there are not enough white blood cells in the thick film field or sufficient blood for a standard examination. The thin film will usually be useless for species diagnosis.



Greasy slides

Blood films made on a greasy slide will spread unevenly, and parts of the thick film will float off during staining. Examination of both thick and thin films will be difficult because of the patchy distribution of blood.



Edge of the spreader slide chipped

When the edge of the spreader slide is chipped, thin films spread unevenly, are streaky and have many 'tails'. Chipped spreaders can also affect the way the thick film spreads.



Other problems with the preparation, collection or storage of unstained blood films can include the following:

- Flies, ants, cockroaches and other insects eat the wet or drying blood and damage the films. *Slides should be covered during drying and then stored overnight in an airtight box or desiccator charged with silica gel.*
- Use of scratched slides for blood films makes microscopic examination of the films difficult. *Scratched or chipped slides should not be used for making blood films. They should be discarded.*
- Uneven drying of thick films leads to variation in the quality of a film, making standard microscopic examination difficult. *Blood films must be dried on a flat, horizontal surface.*
- Autofixation of thick films takes place when slides have been stored for too long at high ambient temperature and humidity without staining. This can happen when slides must be stored without staining, such as slides of known parasitology collected for teaching or slide banks during prolonged field surveys. *Autofixed slides stain poorly, but autofixation can be delayed by keeping the slides in a desiccator charged with silica gel. Avoid placing newly collected slides in direct sunlight or on the floor of a vehicle over a hot exhaust pipe during transport. Thick films can be dehaemoglobinized by immersing them in clean, preferably buffered (pH 7.2), water for about 5 min, thoroughly drying them and storing them in a desiccator.*
- Thick films that are incompletely dried before they are stacked front to back and stored in used cardboard slide boxes will stick to one another. *Slides must be dried completely before they are packed for storage or transport.*

**Read Learning unit 5 in preparation
for the next session.**

Notes

Notes

Learning unit 5

Staining blood films with Giemsa stain

Learning objectives

By the end of this unit, you will be able to:

- **demonstrate** correct operation of the analytical balance;*
- **make up** the buffered water used to dilute Giemsa stain;
- **demonstrate** correct use of the colour comparator or pH meter;*
- **make up** the 2% correcting fluids used to adjust the pH of buffered water;
- **explain** why pH 7.2 buffered water is best for good Giemsa staining;
- **demonstrate** two correct methods of fixing thin blood films;
- **explain** when the 'rapid' and 'slow' Giemsa staining methods are used for malaria microscopy;
- **demonstrate** mastery of the rapid and slow Giemsa staining methods;
- **describe** the correct ways of handling and storing Giemsa stain; and
- **demonstrate** the correct drying and storing of stained slides.

* This objective applies only where this type of equipment is used.

Buffered water

On properly stained blood films, malaria parasites can be seen clearly under the microscope. Before staining blood films, prepare the buffered water used to dilute the stain.

Using buffered water at the correct pH helps to ensure good staining.

pH expresses the acidity or alkalinity of a fluid. It is based on a scale of near 0 (very acid) to 14 (very alkaline). Liquids that are neither acid nor alkaline are described as neutral, at pH 7.0. The pH of a liquid can be measured with a pH meter or with a colour indicator, such as the Lovibond comparator. Paper indicator strips can also be used, but they are rapidly affected by high humidity and become unreliable.

In this unit, you will use the pH meter or comparator recommended in your national malaria control programme.

Water can be made more acid or more alkaline by the addition of certain salts, called buffer salts. These are stored separately until combined in the correct proportions in a fixed volume of water to give the required pH. Buffer salts are weighed on a balance. It is important to ensure that they are stored correctly and cannot absorb moisture from the air; otherwise, they will not work.

Formulated tablets (buffer tablets) are commercially available, which give a specific pH when mixed in a fixed amount of water (usually 1 litre). Buffer tablets do not need to be weighed and are useful in places with limited facilities. They must, however, be kept in an airtight tube under dry conditions; otherwise, they rapidly absorb moisture and must then be discarded. Some workers consider that the results of staining are inferior when buffer tablets are used, but there is no evidence to support this perception.

To prepare buffered water

You will need:

an analytical balance accurate to 0.01 g (a two-pan trip balance is ideal); various single-pan, electrically operated balances are available that are easy to use and suitable;

- filter papers, 11 cm in diameter;
- one glass conical flask, 1 litre capacity;
- one glass beaker, 250 ml capacity;
- wooden spatulas (wooden tongue depressors are readily available);
- distilled or deionized water, 1 litre;
- potassium dihydrogen phosphate (anhydrous) (KH_2PO_4); and
- disodium hydrogen phosphate (anhydrous) (Na_2HPO_4).

The method:

If you are using a traditional, two-pan analytical balance, follow all the steps from 1 to 10. If you are using an electric balance, follow the facilitator's instructions; you will probably start at step 5.

1. Make sure that the pointer of the balance is set at zero by adjusting the balancing screw on the right arm.
2. Place a filter paper in each pan; set the balance to zero, this time by moving the gram weight along the gram scale arm.
3. Move the gram weight a further 0.7 g along the scale arm, ready for weighing the potassium dihydrogen phosphate.
4. Using a wooden spatula, place some of the KH_2PO_4 on the filter paper in the left-hand pan.
5. Transfer the weighed KH_2PO_4 to the glass beaker, add about 150 ml of water, and stir with a clean spatula until the salt dissolves.
6. Place a fresh filter paper in the left-hand pan.
7. Reset the balance as before, but this time adjust the gram weight to 1 g for the Na_2HPO_4 .

8. Using a clean, dry spatula, add the Na_2HPO_4 to the right-hand pan, balancing the weight as described in step 4 above.
9. Add the Na_2HPO_4 to the solution in the beaker and stir as in step 5.
10. When the salts have dissolved, add the solution to the conical flask and top up to the 1 litre mark with water.

The buffered water is now ready for adjustment to pH 7.2 after the correcting fluid has been made up.

To make up the 2% correcting fluids

You will need:

an analytical balance accurate to 0.01 g or better (a two-pan trip balance is ideal, or use an electrically operated one-pan balance);

- filter papers, 11 cm in diameter;
- two glass-stoppered bottles, each of 100 or 150 ml capacity;
- potassium dihydrogen phosphate (anhydrous) (KH_2PO_4);
- disodium hydrogen phosphate (anhydrous) (Na_2HPO_4);
- distilled or deionized water, about 200 ml;
- wooden spatulas;
- two beakers of 250 ml capacity;
- one measuring cylinder of 100 ml capacity; and
- labels.

The method:

1. Follow steps 1 and 2 of the method for making buffered water, then move the gram weight a further 2 g along the scale arm.
2. Weigh 2 g of Na_2HPO_4 and add it to 100 ml of water in the beaker; stir with the spatula until the salts have dissolved.
3. Pour the solution into one of the glass bottles and label the bottle '2% Na_2HPO_4 '.
4. Repeat steps 1 to 3 above, only this time use 2 g of KH_2PO_4 ; label the bottle as such.
5. Store in a cool place away from sunlight.

To check and adjust the pH of buffered water

Check the pH of buffered water routinely before use. To adjust the pH, add small quantities of the correcting fluids to the buffer: 2% Na_2HPO_4 if the pH is below 7.2 (too acid) or 2% KH_2PO_4 if the pH is above 7.2 (too alkaline). Adjustments can be made as outlined below:

Remember:

**There are many kinds of pH meter available.
You will learn to operate the kind used in your country.**

You will need:

- buffered water in a conical flask;
- the two bottles of correcting fluids;
- a pH meter or a pH colour indicator;
- two pH colour indicator glass cells;
- one bottle of bromo-thymol-blue indicator; and
- one measuring pipette, capacity 1 ml.

The method:

1. Pour some of the buffered water to be tested into each of the pH colour indicator glass cells up to the 10 ml mark.
2. Place one cell in the left-hand compartment of the pH colour indicator, as the control cell.
3. Pipette 0.5 ml of bromo-thymol-blue indicator into the other cell, mix, and place the cell in the right-hand compartment.
4. Holding the pH colour indicator towards a clearly lit, white background, turn the disc until its colour matches that in the right-hand cell.
5. Adjust the pH of the water in the conical flask by adding drops of the relevant correcting fluid: Na₂HPO₄ to make it alkaline, KH₂PO₄ to make it acid.

Giemsa stain

Giemsa stain is an alcohol-based Romanowsky stain. It is purchased ready to use or is made up at regional centres by skilled technicians and then distributed throughout the laboratory and malaria control programme network. Giemsa stain is a mixture of eosin, which stains parasite chromatin and stippling shades of red or pink, and methylene blue, which stains parasite cytoplasm blue. White-cell nuclei stain blue to almost black, depending on the type of white cell. This is explained in a later learning unit.

- Some important things to remember with regard to the stock solution of Giemsa stain are:
- Keep the bottle tightly stoppered to avoid evaporation and oxidation of the stain by high humidity.
- Store in a dark glass bottle in a cool, dry, shady place, away from direct sunlight.
- For daily requirements, measure small amounts of stain into a tightly stoppered bottle (about 25 ml), so that the stock solution is less likely to be contaminated.
- Do not add water to the stock solution; even the smallest amount will cause the stain to deteriorate, making staining progressively ineffective.
- Do not shake the bottle of stain before use. Shaking re-suspends precipitates, which settle on films during staining and obscure important details during microscopy.
- Do not return unused stain to the stock bottle or to the bottle used in your daily routine. Once stain is out of the bottle, it must be used quickly or discarded.

Staining blood films

There are two methods of staining with Giemsa stain: the rapid (10%) method and the slow (3%) method. The rapid method is used in outpatient clinics and busy laboratories where a quick diagnosis is an essential part of patient care. The slow method is used for staining larger numbers of slides, such as those collected during cross-sectional or epidemiological surveys and field research.

The rapid (10%) method

This is the commonest method for staining 1–15 slides at a time. It is used in laboratories where a quick result to determine a patient's malaria status is required. The method is efficient, but more stain is used. The need for speed justifies the additional cost.

You will need:

- Giemsa stain, decanted from the stock solution into a 25-ml bottle;
- methanol;¹
- absorbent cotton wool;
- test tubes of 5 ml capacity;
- distilled or deionized water buffered to pH 7.2;
- a Pasteur pipette with a rubber teat;
- a curved plastic staining tray, plate or rack;
- a slide-drying rack;
- a timing clock; and
- a small electric hair-drier.

Thick blood films must be completely dry before being stained. They can be dried quickly with warm air from a small hair-drier or by careful warming over a lamp or a light bulb. Avoid overheating slides as they can 'heat fix' and then stain poorly.

The method:

1. Fix the thin film by dabbing it with a pad of cotton wool dampened with methanol or by briefly dipping the film into methanol. Avoid contact between the thick film and methanol, as methanol and its vapours quickly fix the thick film, and it does not stain well.
2. Using a test tube or a small container to hold the prepared stain, make up a 10% solution of Giemsa in the buffered water by mixing three drops of Giemsa from the stock solution, using the Pasteur pipette, with 1 ml of buffered water. Each slide needs approximately 3 ml of stain to cover it.
3. Depending on whether you are using a staining tray, plate or rack, place the slides to be stained face down on the curved staining tray or face upwards on the plate or rack.

¹ Methanol (methyl alcohol) is highly toxic and flammable; it can cause blindness and even death if swallowed in any quantity. When not in use, it should be stored in a locked cupboard.

4. Pour the stain gently under the staining tray until each slide is covered with stain, or gently pour the stain onto the slides lying face upwards on the plate or rack.
5. Stain the films for 8–10 min. Experience with the stain you are using will help you to decide the exact time needed for good staining.
6. Gently wash the stain from the slide by adding drops of clean water. Do not pour the stain directly off the slides, or the metallic-green surface scum will stick to the film, spoiling it for microscopy.
7. When the stain has been washed away, place the slides in the drying rack, film side downwards, to drain and dry. Ensure that thick films do not scrape the edge of the rack.

The slow (3%) method

This method is less appropriate when a quick result is needed but is excellent for staining large numbers (20 or more) of slides. It is ideal for staining blood films from surveys or research work or batches of slides for teaching. It performs best when slides have dried overnight. The method is economical because much less stain is used (3% rather than 10%).

You will need:

- Giemsa stain;
- methanol;¹
- absorbent cotton wool;
- staining troughs to hold 20 slides placed back to back;
- water buffered to pH 7.2;
- a measuring cylinder, capacity 100–500 ml;
- a measuring cylinder, capacity 10–25 ml;
- a flask or beaker (capacity will depend on the amount of stain to be made up);
- a timing clock; and
- a slide-drying rack.

The method:

1. Fix each thin film by dabbing it gently with a pad of cotton wool dampened with methanol or by dipping it in a container of methanol for a few seconds. Avoid contact between the thick film and methanol, as methanol and its vapours quickly fix the thick film, and it does not stain well.
2. Place the slides back to back in a staining trough, making sure that the thick films are together at one end of the trough.
3. Prepare a 3% solution of Giemsa stain by adding 3 ml of Giemsa stock solution to 97 ml of water buffered to pH 7.2, or multiples of this.
4. Pour the stain into the trough. Do not pour it directly onto the thick films, as they may float off the slides.

¹ Methanol (methyl alcohol) is highly toxic and flammable; it can cause blindness and even death if swallowed in any quantity. When not in use, it should be stored in a locked cupboard.

5. Stain for 45–60 min; experience will indicate the correct time.
6. Gently pour clean water into the trough to float off the iridescent ‘scum’. To avoid disturbing the thick films, pour the water into the thin film end. A less satisfactory way of flushing slides is to immerse the whole trough in a basin filled with clean water and make sure to avoid the iridescent ‘scum’ when removing the trough from the basin.
7. Gently pour off the remaining stain and rinse with clean water.
8. Carefully remove the slides, one by one, placing them film side down in the drying rack to dry. Make sure that the thick films do not touch the edge of the rack.

During staining with Giemsa stain (3% or 10%), the surface is covered with a metallic green scum. Avoid getting it onto blood films during rinsing as it can impair examination.

Care of glassware and measuring equipment

Measuring cylinders, pipettes, staining troughs and beakers must be clean and dry before use. Staining blood films with dirty utensils gives unsatisfactory results.

The equipment used for Giemsa staining should be rinsed immediately after use in clean water to remove as much of the stain as possible. It should then be soaked for a while in a detergent solution before washing. Washing utensils with a mild detergent is satisfactory, provided they are rinsed thoroughly in clean water before drying. Any detergent that is left on glass and plastic-ware can alter the pH of the water and the stain, resulting in poor staining when the equipment is next used.

Read Learning unit 6 in preparation for the next session.

Notes

Learning unit 6

The microscope

Learning objectives

By the end of this unit, you will be able to:

-
- **demonstrate** the correct set-up and use of a binocular microscope with artificial and with natural light;
 - **demonstrate** the correct use of the x10 paired oculars and x100 oil immersion objective;*
 - **operate** the mechanical stage correctly;
 - **name** correctly 10 component parts of the microscope;
 - **describe** the correct way in which to maintain a microscope in good working order;
 - **describe** two ways of storing a microscope correctly; and
 - **demonstrate** the correct way of packing a microscope for long-distance transport.
-

* Or x7 oculars if they are used in the programme

For efficient malaria microscopy, learn to use the microscope correctly; know its limitations and how to keep it in good working condition.

Monocular microscopes have a single eyepiece (ocular). They are most useful when no power supply is available. Daylight provides a bright microscopic field for monocular microscopes. Binocular microscopes, with two eyepieces, have replaced monocular ones, as they are more comfortable to use, but daylight provides poor illumination for these microscopes.

The microscope you will use during training and back at your home base is called a *compound binocular microscope*. Optimal malaria microscopy is done with microscopes fitted with x10 paired eyepieces and an x100 oil immersion objective.¹

To ensure the high standards of illumination required for routine binocular malaria microscopy, it is essential to have a good, reliable source of artificial light. If a constant supply of electricity is not available, a generator can be used. Delivering

¹ Some programmes prefer x7-paired oculars but they are not easy to obtain. The x7 ocular covers more blood per field and is therefore considered by some workers to be more sensitive.

even small generators and fuel to remote clinics can be difficult, however, and high running costs make this method unacceptable. Cheaper, easier sources of artificial light for microscopy are light-emitting diodes (LED), a form of electroluminescence that can be derived from small, low-voltage batteries. The batteries can be charged by a small solar panel mounted on a pole or the roof of the laboratory. A range of these products is available on the market. Most are affordable, easy to use and require minimal maintenance. Your facilitator will discuss this subject further, depending on how important it is to you and the programme.



The LED light illustrated here can run for a minimum of 200 hours on four standard 1.5-volt batteries.

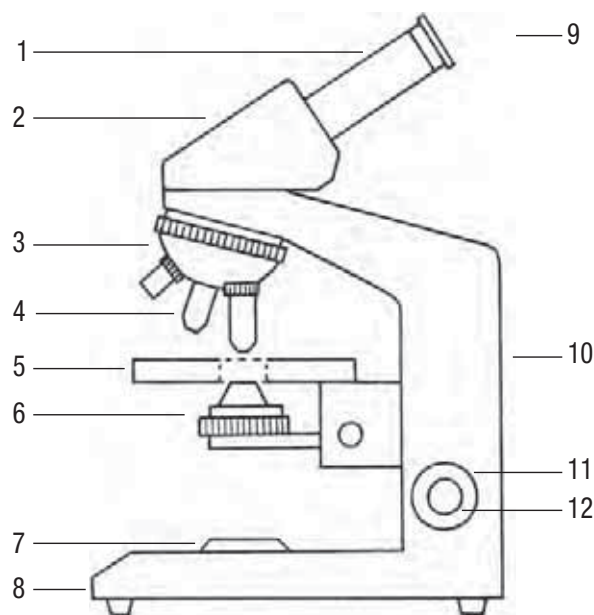

Parts of the compound binocular microscope

The main parts of a typical compound binocular microscope are shown above.

1 and 2. Main tube and body tube

Collectively called the microscope head, the main tube and body tube are designed to slope towards the user and are called an ‘inclined head’. Polished glass prisms

inside the body tube of the inclined head bend the light so that the image reaches the user's eyes through the paired oculars.

3. Revolving nosepiece

Three or four objective lenses of different magnifications screw into the nosepiece. The nosepiece revolves to place a different objective over the specimen, in line with the eyepieces, which increases or decreases magnification of the specimen.

4. Objective lenses

All the parts of the microscope are important, but the objective lenses must be treated with particular care. An objective consists of two or more lenses kept in place by a special glue or cement. Solvents such as alcohol, xylol and acetone can dissolve the cement holding the lens in place and should not be used to clean the objectives or any other part of the microscope.

An objective is referred to by its magnifying power, which is usually marked on the side of the body. Each microscope usually has a x10, a x40 and a x100 objective. The x100 is called the 'oil immersion objective' and can be identified by a distinctive black, red or white ring.

When you examine an objective lens, you will notice that the size of the front lens decreases with the magnifying power. The working distance between the front lens and the focused specimen on the stage changes with the magnification. Thus, the higher the objective's magnifying power, the shorter the working distance. Care must therefore be taken not to damage the specimen with the objective lens.

Although there may be small variations according to the manufacturer, the working distance for each objective is approximately:

x10 15.98 mm

x40 4.31 mm

x100 1.81 mm (oil immersion)

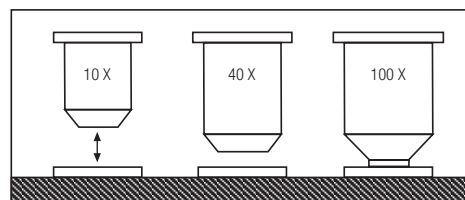

Objectives, showing working distance between front lens and specimen

The microscope must be used with care, as specimens, slides and even the objective lens can easily be damaged by rough manipulation or when objectives are changed.

5. Mechanical stage

The mechanical stage holds the slide secure while allowing specimens to be moved smoothly. A scale fitted to two sides shows the specimen's position and subsequent movement during examination. This scale is called the Vernier scale. You will use this scale to trace portions of the blood film that should be re-examined or shown to others. In modern binocular microscopes, the stage moves when the specimen is focused. In older microscopes, the body and tube move during focusing.

6. Substage condenser, iris diaphragm and filter holder

The substage condenser consists of a number of lenses that centre the light from the source or mirror onto a central spot on the microscopic field. The substage condenser can be raised or lowered to give maximum or minimum illumination.

Inside the condenser is the iris diaphragm, which is used to control the amount of light passing through the condenser. It consists of a number of thin, interlocking metal leaves, which are adjusted by moving a small lever.

Beneath the iris diaphragm is the filter holder, in which a frosted blue-glass filter is placed when electricity is the light source. This makes the microscopic field appear white rather than yellow.

The procedure for setting the correct illumination of the microscope, i.e. Köhler illumination, is important for optimum resolution and contrast, ensuring an evenly illuminated field, removing glare and reducing heating of the specimen, as described in the enclosed CD-ROM.

7. Illuminator

Modern microscopes have a fixed illuminator, in which a built-in prism mirror brings light to the microscopic field. Others have a removable illuminator, which can be replaced by a mirror when electricity is not available.

The substage mirror is used to direct light from the light source to the microscope field. It has two sides: one plane (flat) and the other concave. The flat surface is used with the substage condenser. The concave side is used without the substage condenser, as the curved surface itself acts as a condenser.

8. Base or foot

To avoid movement or wobbling, the solid base, or foot, of the microscope must rest on a firm, flat surface. The shape of the foot may vary. Most have a threaded hole in the underside of the base to receive a securing screw that keeps the microscope rigid in the box during transport.

9. Ocular, or eyepiece

The top of the main tube of modern microscopes is fitted with a binocular head, i.e. with two oculars, one for each eye. Monocular microscopes are seldom used today in national malaria control programmes.

The ocular fits into the upper end of the main tube, and the microscopist looks through it when using the microscope. The magnifying power of each ocular is marked on it. The 'magnifying power' is the number of times by which it will magnify the image produced by the objective. For example, with oculars of x10 and an oil immersion objective of x100, the total magnification of the specimen would be $10 \times 100 = 1000$ diameters. The magnification is actually a little more, but 1000 diameters is accurate enough for our purposes.

Oculars are available in a range of powers, from x5 to x25 or even x30. In malaria microscopy, a range of x6 to x10 is used routinely. One large programme has used x5 oculars for many years. Today, x10 is probably the most commonly used. Programmes are strongly advised to use oculars between x7 and x10 for routine malaria microscopy.

Oculars fitted to binocular microscopes are called paired oculars. The marking 'x10P' on the rim of a x10 ocular indicates that it is one of a paired set of eyepieces.

10. Arm or limb

The arm forms a rigid support for the main tube and stage of the microscope. It is robust and can be used as a handle for carrying the microscope. When carrying a microscope in this way, always support the base of the microscope with the other hand.

11 and 12. Coarse and fine adjustments

The two adjustment systems, coarse and fine, are used to focus on the specimen being examined. The coarse adjustment is used for rapid, relatively large vertical focusing movements, while the fine adjustment is for the more precise focusing required with higher-powered objectives. In modern microscopes, the coarse and fine adjustments raise and lower the mechanical stage. In older microscopes, the main tube is raised to focus.

Usually, a specimen is first examined with the coarse adjustment and then examined in detail with the fine adjustment.

The coarse adjustment is used differently when the oil immersion objective is used, as will be explained in a later learning unit.

Use of the microscope

In the practical sessions, you will use and become familiar with all the features of the microscope. Early on, you will see the image of the specimen becoming larger as the magnification is increased. This takes place when you change objectives. You will also examine everyday objects and see how different they look under the microscope. These exercises are designed to help you learn to adjust the illumination correctly and to use the substage condenser and iris diaphragm. You will also practise using the mechanical stage and Vernier scale.

The light source

A good source of artificial light is needed to examine specimens properly. Light that is either too bright or too dim will interfere with malaria microscopy.

When the oil immersion objective of a binocular microscope is used routinely, electric light from a mains supply or a generator should be used. Battery-operated LED light sources are a useful alternative when electric light is not available and should be directed towards the mirror. Artificial LED light travels through the mirror on a path from the source as follows:

source → mirror → substage condenser and diaphragm → specimen → objective → oculars

When artificial light is used, a frosted blue filter must be placed between the source and the substage condenser. The flat side of the mirror is used.

Daylight should be used only in an emergency. When daylight is the light source, the concave mirror should be used without the substage condenser. It is dangerous to point the mirror directly at the sun when obtaining illumination, as serious damage can be caused to the eyes.

Obtaining even illumination

Using x10 paired oculars and an x10 objective:

1. Place the slide on the mechanical stage, with the specimen over the central opening in the stage.
2. Focus on the specimen using the coarse adjustment.
3. Make sure that the iris diaphragm is wide open, and raise the substage condenser until the microscopic field is brightest.
4. Remove the eyepieces and, looking down the tube, adjust the mirror (if it is being used) until the objective lens is fully illuminated.
5. Replace the eyepieces. Use the fine adjustment to sharpen the focus on the specimen.
6. Remove the eyepieces again, and slowly close the iris diaphragm until the aperture of the objective is two-thirds visible. The specimen will appear clearer, with maximum resolution.
7. Replace the eyepieces, and revolve the nosepiece to select the objective you want to use. Each time you change the objective, you must refocus.
8. If the intensity of the light from the substage lamp is constant, the illumination can be adjusted by increasing or decreasing the aperture of the iris diaphragm. In some microscopes, it is possible to adjust the intensity of the light from the substage lamp.

Using the oil immersion objective

When preparing the microscope for oil immersion microscopy:

1. Arrange the illumination as described above, then observe the next steps from the side of the microscope.
2. Using the coarse adjustment, rack the stage down, away from the objective lens.
3. Place the slide on the microscope stage, with the blood film uppermost.
4. Making sure that there will be sufficient space between the stage and the x100 objective, revolve the nosepiece until the x100 objective is over the specimen.
5. Place one or two drops of immersion oil on the area of the blood film to be examined.
6. Using the coarse adjustment, move the stage until the objective lens is in contact with the immersion oil. Raise the stage slightly, making sure that the lens and oil remain in contact.
7. Looking down the eyepieces, focus on the specimen with the fine adjustment. Make sure that the lens does not touch the slide. Correct the illumination by adjusting the iris diaphragm.

Immersion oil is used between the microscope slide and the objective lens to reduce scattering of transmitted light. The oil must reproduce the optical properties of the glass used for the lenses and must therefore have a refractive index of 1.515, which is approximately 1.5 times the refractive index of water.

Commercially available immersion oils can be cleaned off the objective lens with a soft cotton cloth. Do not use this cloth to clean other lenses. Immersion oil on blood films can be gently washed away with the solvent recommended by the manufacturers, or the slides can be placed face down for a while on clean, white absorbent tissue paper that soaks up the oil. Some workers wipe the oil off films with absorbent tissue, but this method is rough and is not recommended. Another method is to roll examined slides in white tissue paper (toilet paper will do), with one layer of tissue paper between each slide. After a few days, when the paper has absorbed the oil, the slides can be removed from the paper. Coloured tissue should not be used as it is often acidic and will de-stain blood films.

Care of the microscope

Provided normal care and common sense are exercised, your microscope will remain in good condition for many years.

Removing dust and grease

During the day, when the microscope is not in use, it should be kept covered with a clean cloth or plastic cover to protect the lenses from settling dust. Overnight, or if the microscope will remain unused for a long time, it should be placed inside its box, with the door tightly closed. To protect the objective lenses, the x10 objective should be rotated to line up with the ocular.

Oil from eyelashes, facial skin and fingers is easily deposited on lenses and oculars during use. These parts should be cleaned carefully with lens tissue or a soft cotton cloth.

Oil immersion objectives must be cleaned immediately after use. If not, the oil will thicken and harden over time, and the objective will become useless. To avoid further transfer of oils, never use contaminated cloths to clean other objectives, oculars or the mirror.

Preventing fungal growth

In warm, humid climates, fungal growths are easily established on lenses and prisms. Fungal growth causes problems and can become so bad that a microscope cannot be used. In such cases, the affected surfaces might have to be cleaned and repolished—a job usually done by the manufacturer, which takes time and can be expensive.

- Fungus cannot grow on glass surfaces when the atmosphere is dry. Therefore, it is important to store the microscope in dry conditions when not in use. One of the following methods should be used.
- Keep the microscope in a 'warm cupboard', which has a tightly fitting door and two or more, constantly burning 25-watt bulbs, depending on the size of the

cupboard. The temperature inside the cupboard should be a constant 30–35 °C, with low humidity.

- Keep all lenses and prism heads in an airtight box or desiccator containing active silica gel, which is a ‘desiccant’ and absorbs water vapour from the air. Self-indicating silica gel is blue when active and becomes pink as it absorbs water vapour. When it is bright pink, it can be reactivated by heating; it is ready to use again (after cooling) when it has become bright blue.
- If possible, keep the microscope in a continuously air-conditioned room. Rooms that are air-conditioned only during the working day are not suitable.

Transporting the microscope

When transporting the microscope between laboratories or to the field, it is important to ensure that it is properly secured inside its box. The best way to do this is by screwing the securing device through the hole in the bottom of the box into the base or foot of the microscope. When this is done correctly, the microscope remains rigid in its box on even the roughest road.

**Read Learning unit 7 in preparation
for the next session.**

Notes

Learning unit 7

Examining blood films

Learning objectives

By following each step in this Learning unit, you will be able to:

- **list** the components of normal blood;
- **demonstrate** each method used for examining a thick blood film and a thin blood film for malaria parasites;
- **recognize** and classify the normal components of blood;
- **name** correctly the main parts of a white blood cell; and
- **recognize** common contaminants of blood films.

Note: The standards of accuracy required are not listed for these learning objectives. The tutor will designate the levels of accuracy expected for the competence and the methods for assessment during this course.

Components of normal blood

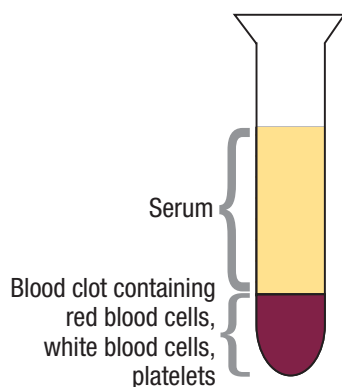

When blood is taken directly from a vein and collected in a test-tube, it is a red liquid. After standing for 5–20 min, the blood separates into two layers, as in the diagram. The serum layer is a pale-yellow fluid; the blood clot is a semi-solid substance that becomes dark-red or almost black. The clot contains red blood cells, white blood cells and platelets. These components are very small and can be seen only with the aid of a microscope, on a blood film made from freshly taken blood and dried and stained before examination.

Quantities of blood larger than that obtained from a finger-prick are usually taken directly into a tube treated with an anticoagulant, which prevents the blood from clotting. Clotted blood cannot be used in many laboratory procedures. Films made with anticoagulated blood must be handled carefully, as it adheres poorly to the slide. Some anticoagulants change the pH slightly, which can affect the quality of

staining. If anticoagulated blood is left standing on the bench or left in the refrigerator for more than 1 or 2 hours, the morphology of components like white blood cells, platelets and parasites can change and make diagnosis difficult.

What do normal blood components look like?

The normal appearance of the various components of a thick and a thin blood film is always slightly different, and it is important to be able recognize them.

Blood in Giemsa-stained thin films

Thin films examined with the x100 oil immersion objective and the x10 ocular contain: red blood cells (or erythrocytes), white blood cells (or leukocytes) and platelets (or thrombocytes).

Red blood cells

The shape of the red blood cell, or erythrocyte, is described as a biconcave disc. It is the commonest cell in thin blood films. There are about 5 000 000 in each microlitre (μl) of blood. With Giemsa staining, the red cell appears as a pale-greyish to light-pink disc measuring about 7.5 μm in diameter.

Red blood cell or erythrocyte



The red cell does not have a nucleus. Some cells may appear larger than normal red blood cells (normocytes) and in some rare cases may even appear oval.

White blood cells

The number of white blood cells, or leukocytes, per microlitre of blood is normally 6000–8000, much fewer than red cells. The number can vary widely under certain conditions and in some individuals. There are several types of leukocyte. As each stains differently, they are easy to distinguish with practice. The parts of a typical white blood cell are shown in the illustration.

A white blood cell

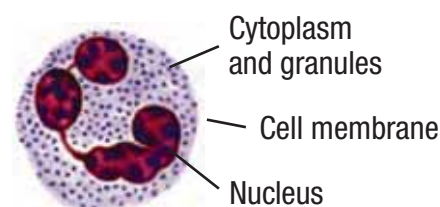

Each leukocyte has a nucleus surrounded by cytoplasm; sometimes, the cytoplasm is granular. Some leukocytes have a multilobed nucleus, as shown in the illustration above. Leukocytes are divided into two groups, polymorphonuclear and mononuclear leukocytes.

Polymorphonuclear leukocytes

Neutrophils make up 65% of the total white cell count in a healthy person. They have well-defined granules in the cytoplasm, and their nuclei stain a deep purple. When a malaria parasite is present, neutrophils may contain 'malaria pigment', which is a by-product of parasite metabolism and is all that remains of parasites that have been phagocytosed (engulfed or eaten) by the neutrophil. Malaria pigment can be golden brown to almost black. It does not take up Giemsa stain.

Eosinophils make up 1–4% of the total white cell count in a healthy person. The granules are a distinctive pinkish ('eosin') colour and are a good indicator of staining quality. The number of eosinophils can increase dramatically in diseases like asthma, helminthiasis and other infections and allergies. When the percentage of eosinophils is 8% or higher (eosinophilia), the fact must be recorded and reported to the clinician.

Basophils are rare, making up less than 1% of the total. They are seen as large blue or mauve granules in the cytoplasm after Giemsa staining.

Mononuclear leukocytes

Monocytes are the largest of the white blood cells, measuring 12–18 µm in diameter. The nucleus is large and kidney or bean shaped; the cytoplasm may contain a few granules that stain pinkish or red. Monocytes make up 2–10% of the total white cell count, and, like neutrophils, they actively phagocytose malaria parasites.

Lymphocytes occur as two types, large and small, and together they comprise 20–45% of the total white cell count. The nucleus of a large lymphocyte is round and deep-mauve. The large area of cytoplasm stains a clear water-blue and may contain a few mauve-staining granules. Small lymphocytes are slightly larger than a normal red blood cell. There is little cytoplasm surrounding the nucleus, which stains dark-blue and sometimes almost black.

Platelets

Platelets are small, irregularly shaped bodies, without a nucleus but with fine red granules on a blueish background. Like eosinophils, platelets can be used as sensitive indicators of the quality of staining. Numbering about 100 000 per microlitre of blood, they usually occur in groups of 5–10 but form larger clumps when a blood film is poorly made. Inexperienced microscopists may confuse them with malaria parasites.

Blood in Giemsa-stained thick films

When a stained thick blood film is examined under a x100 oil immersion objective and x10 paired oculars, the viewer will see the remains of red blood cells, white blood cells and platelets. The white blood cells and platelets look much the same as in thin films, except that the cytoplasm around the nuclei is not visible.

A thick blood film consists of dehaemoglobinized red blood cells, layer on layer in a thick mass. When a thick film is stained, the water in the stain acts on the unpreserved red cells, and the haemoglobin in the cells dissolves into the water. This process is called 'dehaemoglobinization'. It can be observed when an unstained thick film is placed in a Petri dish of clean water. As soon as the slide enters the water, the

red haemoglobin starts to flow out, leaving the thick film pale and opaque after a few minutes. This takes place during staining, and all that remains when staining is complete are the remnants of red blood cells, stained white cells and platelets.

The illustrations below will help you to identify the red cells and the kinds of white cells that are present, as well as platelets. Until you gain experience in their identification, confirm each classification with your facilitator. You will notice that these illustrations, and most of those in this handbook, are colour drawings. This is because, in the beginning, it is not easy to recognize stained blood elements under the microscope. Coloured drawings make it easier to do so. As you gain experience, you will probably progress from checking against the drawings to checking against the microphotographs (photographs taken down the microscope) shown in the *Bench aids*.

In the exercises that follow, you will also become familiar with artefacts and blood contaminants. These can make diagnosis of malaria parasites difficult, but you will find less difficulty as you gain in experience. Artefacts and blood contaminants are also dealt with in Learning unit 8.

How blood elements appear in thick and in thin blood films

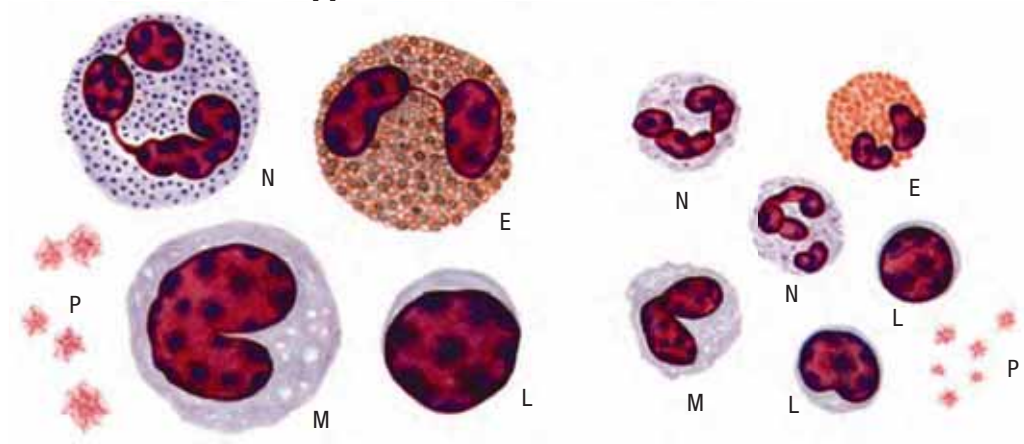

Thin Film LEUKOCYTES Thick Film
 N = Neutrophil, E= Eosinophil, M = Monocyte, L = Lymphocyte, P = Platelets

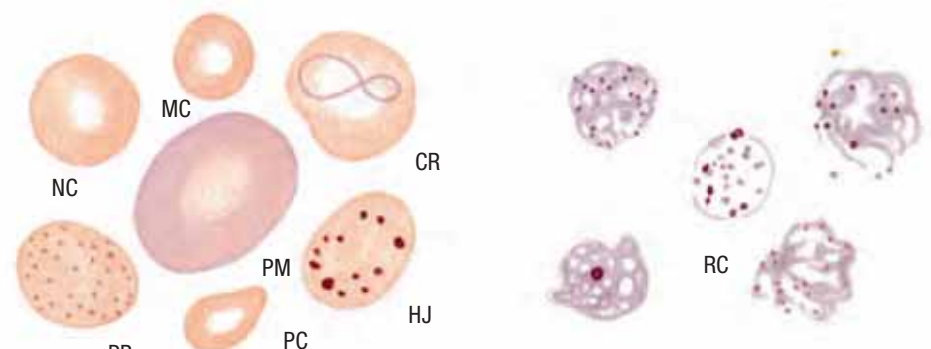

Thin Film ERYTHROCYTES Thick Film
 NC = Normocyte, MC = Microcyte, PM = Polychromatic macrocyte, PC = Poikilocyte,
 PB = Punctate basophilia, CR = Cabot's ring, HJ = Howell-Jolly bodies, RC = Reticular 'clouds'
 and chromatoid bodies in severe anaemia

Artefacts and contaminants that can cause confusion



'Clouds' and chromatoid debris derived from immature erythrocytes in severe anaemia



Isolated groups of eosinophilic granules



Blood platelets. Lymphocyte for comparison of size

BLOOD ELEMENTS



BACTERIA

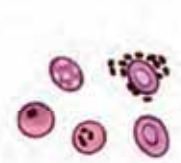

SPORES



Hyphae and spores FUNGUS

VEGETABLE CELLS



Dust particles



Giemsa stain crystals



Herring-bone scratches in glass slide



Crystalline 'pits' in devitrified slide

VARIOUS SOURCES

Read Learning unit 8 in preparation for the next session.

Notes

Learning unit 8

Examining blood films for malaria parasites

Learning objectives

By following the steps in this Learning unit and meeting each of the standards established for your course, you will be able to:

- **name** the parts of a malaria parasite correctly;
- **distinguish** malaria parasites in thin and in thick films, identifying trophozoite, schizont and gametocyte stages;
- **identify**, in thin and in thick films, the four human species of malaria parasite, *P. falciparum*, *P. vivax*, *P. malariae* and *P. ovale*;
- **describe and demonstrate**, in thick and thin blood films, the main morphological differences between the four species of human malaria parasite;
- **demonstrate** common contaminants seen in blood films that are often mistaken for blood components or malaria parasites;
- **recognize** and name other blood parasites common to humans in your area; and
- **describe** ways of preventing some artefacts from contaminating blood films.

Accuracy continues to be an important element of your work. To achieve and maintain the set levels, you will have to examine a range of blood films for practice and to gain experience. In addition to the advice available from your facilitator, this Learning unit contains an extensive range of diagrams, and the microphotographs in the Bench aids can be consulted. These will help you work on your own, before confirming your final diagnosis with the facilitator.

Although the level of accuracy expected of trainees attending this course were set separately¹ and are not described here, the level will be 90% for distinguishing malaria parasites in thin and thick films and identifying trophozoite, schizont and gametocyte stages and 80% for identifying the four human species of malaria parasite. The level attained by trainees will be assessed on the basis of their examination of a standard set of slides provided by the tutor. While these levels may seem high, they are at the low end of the range. As your experience, knowledge and skills improve, your accuracy will increase significantly. With this approach and continuous practice, you will not find it difficult to achieve an accuracy of 80% for some activities. Many participants will consistently reach higher levels of competence.

¹ WHO. *Malaria microscopy quality assurance manual*. Manila, Western Pacific Regional Office, 2009.

Recognition of a malaria parasite

Giemsa stain colours each part of a malaria parasite differently. With good staining, it is easy to distinguish the parts shown in the diagram.

Parts of a malaria parasite in a red blood cell

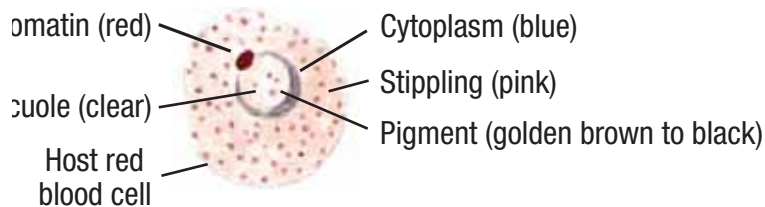

Buffered water at a stable pH 7.2 is essential for good staining of parasites and white cell elements. Without a stable pH, the staining will vary widely and, depending on the pH, can be similar to those in the diagram below.

Effect of pH on parasite morphology

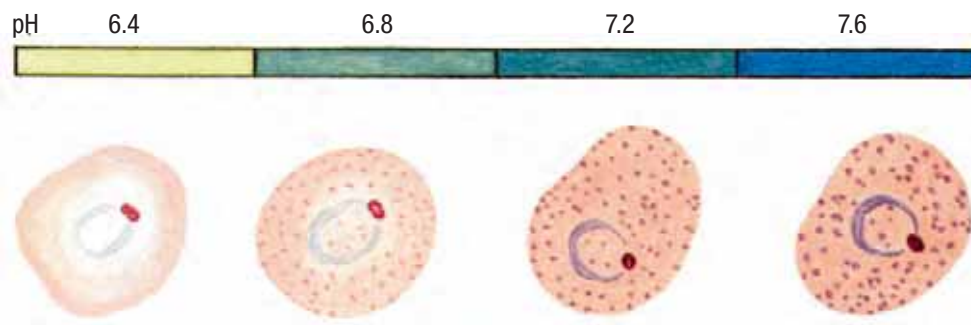

Malaria parasites pass through a series of developmental stages, during which their shape varies widely. Nevertheless, the same parts of the parasite stain the same colour at each stage.

- **Chromatin**, part of the parasite nucleus, usually round, stains bright red.
- **Cytoplasm** stains blue; the tone of blue may differ between species and is sometimes a differentiating characteristic.
- **Pigment** is a granular by-product of parasite growth. It does not take up stain but varies in colour from golden-brown to black. The colour and size of pigment granules varies according to the species and, with colour, is often characteristic.
- **Stippling**, 'spots', 'dots' or 'clefts' are descriptions of the effect that the parasite has on the host cell, which is emphasized by good staining. The best known and easiest to demonstrate is 'Schuffner stippling', the mass of pink dots that appears to fill some *P. vivax*-parasitized red blood cells. In *P. ovale* infections, the almost

mauve stippling, which can even obscure the parasite itself, is called 'James dots', although most workers continue to use the term 'Schuffner stippling' to describe it. Other dots or clefts, such as 'Maurer clefts', seen in some parasitized cells in thin films of *P. falciparum*, are less easy to demonstrate and depend on the quality of staining.

Stages of the malaria parasite

During these practical exercises, you will first learn to recognize malaria parasites and their stages in thin blood films. This is an exacting task, and you will be encouraged to practise and work on your own as much as you can.

To help you through these exercises, use the thin and thick film key on pages 55–56 and the diagnostic aids in Figures 3, 4 and 5 and Plates 4–8 of this handbook. As you become more familiar with what you see, you will find that the photomicrographs in the Bench aids will be of increasing help. Until you are more experienced, continue to confirm your diagnoses with your facilitator.

The trophozoite stage

This is the most commonly seen stage. Often called the ring stage, the 'ring' may appear incomplete in thick films. The trophozoite can vary from small to quite large within the host cell. Usually, there is one chromatin dot; two are common in *P. falciparum*. The cytoplasm takes different shapes, from a definite, fine ring to forms that are irregular or bizarre, sometimes called 'amoeboid'. As the parasite grows, pigment appears. It does not stain but ranges in colour from golden-brown to dark-brown or even black.

Trophozoites

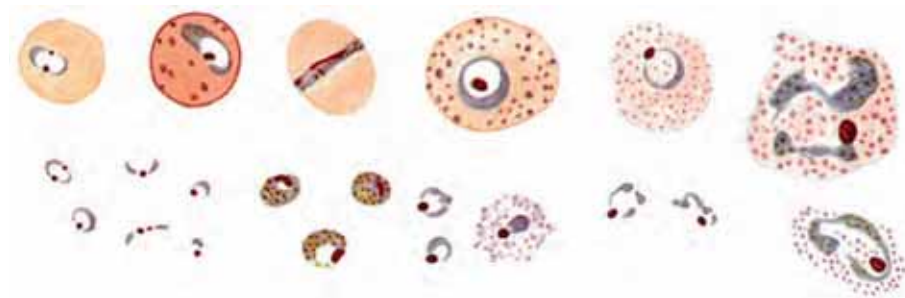

Upper line: thin film parasites. Lower line: thick film parasites

The schizont stage

This stage is easily recognized. It begins when the trophozoite has reached its full capacity and the chromatin divides into two. The parasite starts to reproduce asexually, i.e. the cell divides into ‘daughter cells’ (merozoites) by simple division. Several more divisions of the chromatin follow, which mark the growth of the schizont, until there are many chromatin bodies, each with its accompanying cytoplasm. The number of chromatin and merozoite divisions helps to identify the species. These clearly delineated new parasites are now ready to leave the host cell to invade new red blood cells.

Schizonts

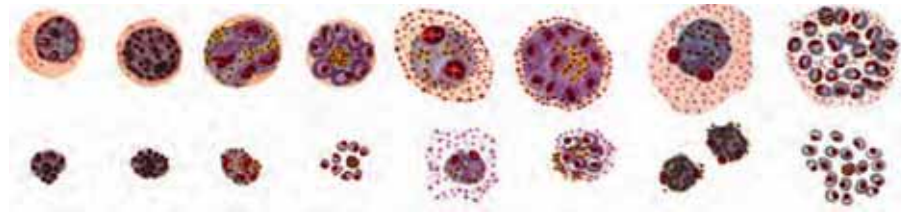

Upper line: thin film schizonts. Lower line: thick film schizonts

Note: The formation of schizonts in malaria parasites (asexual reproduction) takes place in both the liver (exoerythrocytic) phase and the red blood cell (erythrocytic) phase. In both phases, this is referred to as ‘schizogony’.

The gametocyte stage

The parasite develops into either a male or a female gametocyte in preparation for the sexual phase in the female Anopheles mosquito vector. Gametocytes are round or banana-shaped, depending on the species. The way in which the parasite takes up the stain helps to identify the sex of the parasite in thin films: male (microgametocyte) or female (macrogametocyte). Differentiating between male and female gametocytes is difficult in thick films.

Gametocytes

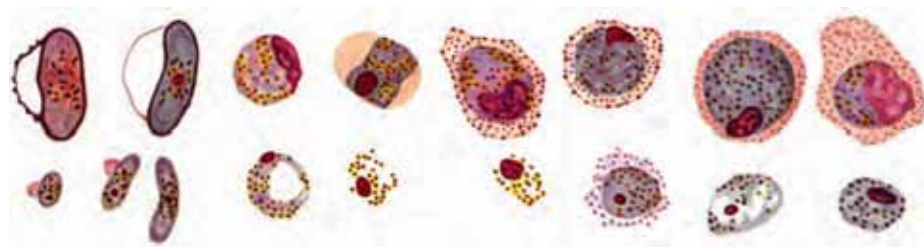

Upper line: thin film male, female gametocytes. Lower line: thick film gametocytes

Key to identifying malaria parasite stages in thin and thick blood films

Do you see:

Thin film

Thick film

1. one or more red chromatin dots with attached blue cytoplasm?

Yes: Go to 2.

No: What you see is not a parasite.

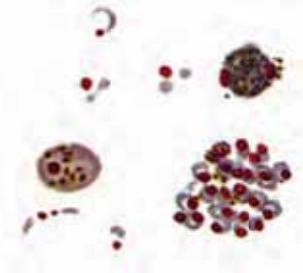
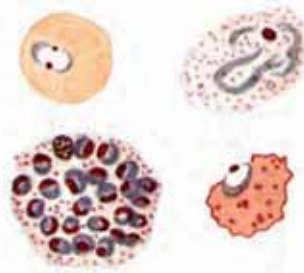

2. the size and shape right for a parasite?

Yes: This is probably a malaria parasite; go to 3.

No: What you see is not a parasite.

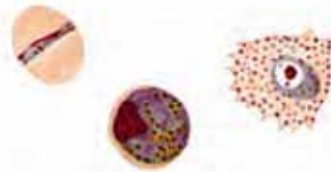

3. pigment in the 'cell'?

Yes: Go to 7.

No: Go to 4.



4. one chromatin dot attached to a ring of blue cytoplasm containing a vacuole?

Yes: This is a trophozoite.

No: Go to 5.



5. one chromatin dot attached to small, solid blue cytoplasm, with no apparent vacuole?

Yes: This is a trophozoite.

No: Go to 6.

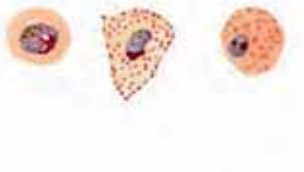

6. one chromatin dot and irregular or fragmented blue cytoplasm?

Yes: This is a trophozoite.

No: Go to 8.



7. a chromatin dot in the parasite with pigment?

Yes: Go to 8.

No: Go to 9.



Do you see:

Thin film

Thick film

8. a vacuole in the parasite or cytoplasm that is fragmented in some way?

Yes: This is a trophozoite.

No: Go to 11.

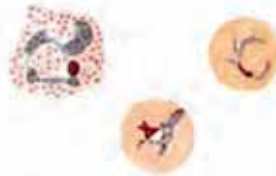

9. two chromatin dots attached to a ring of cytoplasm and a vacuole?

Yes: This is a trophozoite.

No: Go to 10.



10. 2–32 chromatin dots and pigment?

Yes: This is a schizont stage.

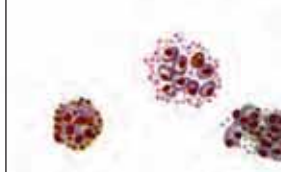
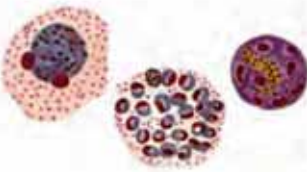

11. a rounded or a banana shape?

Rounded: Go to 12.

Banana-shaped: Go to 14.



12. clear-red chromatin and deep-blue cytoplasm in the rounded body?

Yes: This is a female gametocyte.

No: Go to 13.

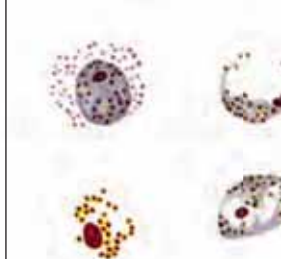

13. that the rounded body has stained a reddish colour so that the chromatin is not clear?

Yes: This is a male gametocyte.

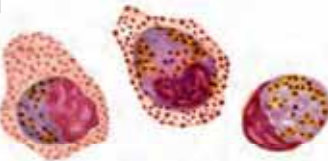

It is difficult to tell the difference between male and female gametocytes in thick films.

14. a banana-shaped parasite with densely stained blue cytoplasm and bright red chromatin?

Yes: This is a female gametocyte.

No: Go to 15.

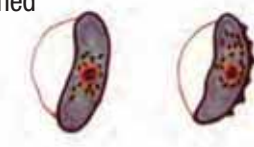

15. a banana-shaped parasite with a reddish overall colour so that the chromatin is indistinct?

Yes: This is a male gametocyte.

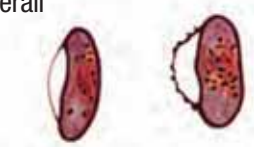

It is difficult to tell the difference between male and female gametocytes in thick films.

Species of malaria parasite

In learning to recognize malaria parasites and their stages, you have so far concentrated on what the parasites look like. Now it is time to move on to ways of identifying each of the malaria parasite species. The effect the parasite has on the host red blood cell is of great importance to diagnosis.

Species that cause human malaria

There are four species of malaria parasite that naturally infect humans:

Plasmodium falciparum is the commonest species in tropical parts of the world. It is responsible for most cases of severe malaria and death.

Plasmodium vivax is the commonest species in the cooler parts of the tropics. It is the largest of the human malaria parasites and the cause of much illness and absenteeism from work and school.

Plasmodium malariae is less common but is found in much of the tropical world.

Plasmodium ovale is considered a rare species. It is relatively common in West Africa and other parts of the African continent, and isolated cases have been reported in countries as widely separated as China, Papua New Guinea, the Philippines, Sudan and Thailand. Because of morphological similarities, *P. ovale* is sometimes mistaken for *P. vivax* by less experienced microscopists.

The following comments apply to correctly stained blood films. Poor staining does not show Schüffner stippling, an important aid in diagnosing *P. vivax*. Even with good staining of thin films, Maurer clefts of *P. falciparum* are difficult to demonstrate. Good quality staining is critical to accurate diagnosis and the patient's well-being.

Appearance of parasite species in thin blood films

A guide to distinguishing between the four species starts with the effect the parasite has on the infected red blood cell.

- Is the cell enlarged?
- Does the infected red blood cell have some kind of stippling?

With *P. vivax* and *P. ovale*, good staining shows Schüffner stippling or James dots. With *P. falciparum*, Maurer dots or clefts are less commonly seen.

The diagnostic features outlined in Figure 6 will help guide you in deciding the species of parasite. Continue to work as much as you can on your own. Your facilitator will help resolve any problems you may have.

Malaria species differentiation in thin films

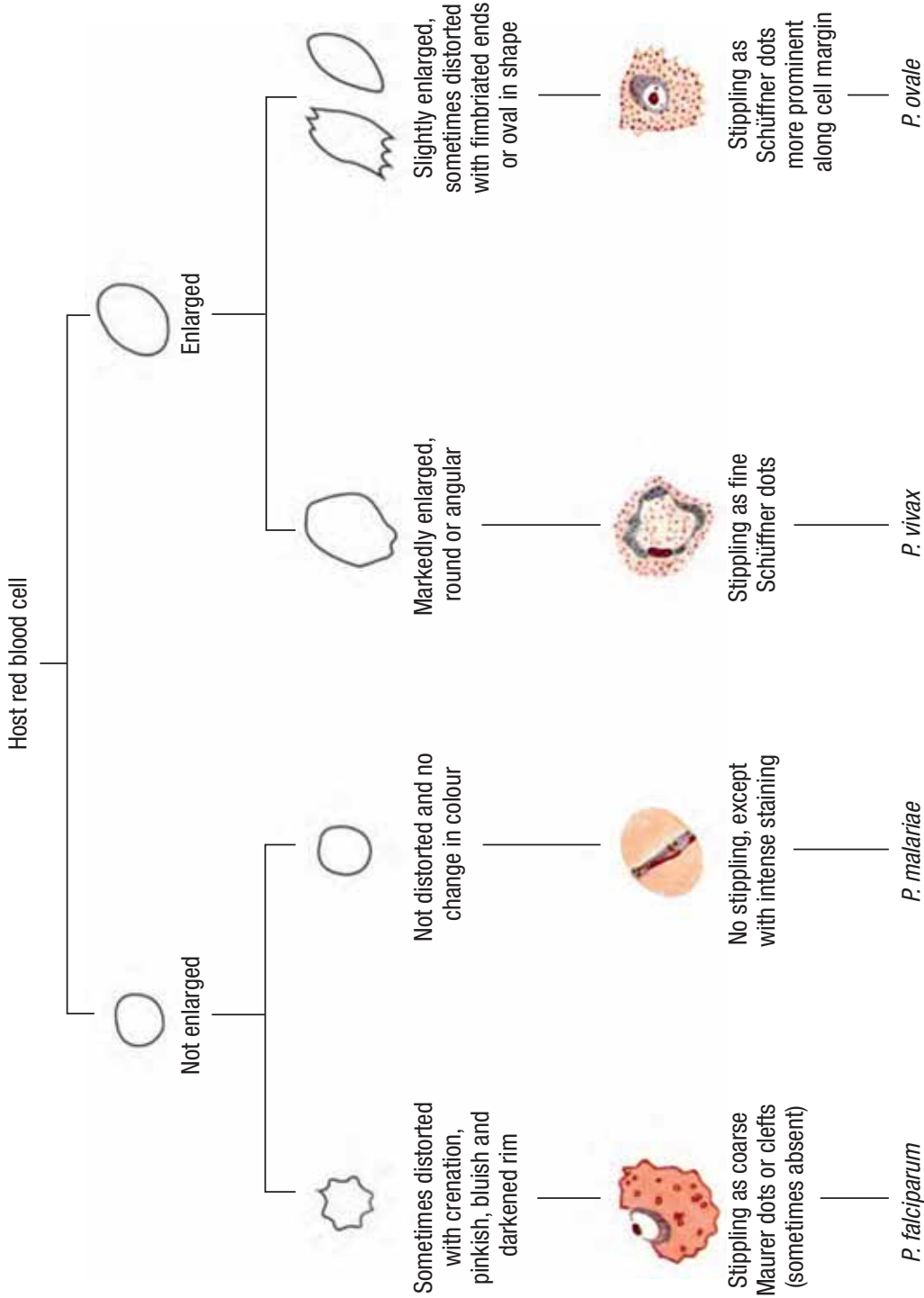

Malaria species differentiation in thin films using host-cell changes and presence of stippling (Giemsa stain)

Differentiation of malaria parasite species in thick films

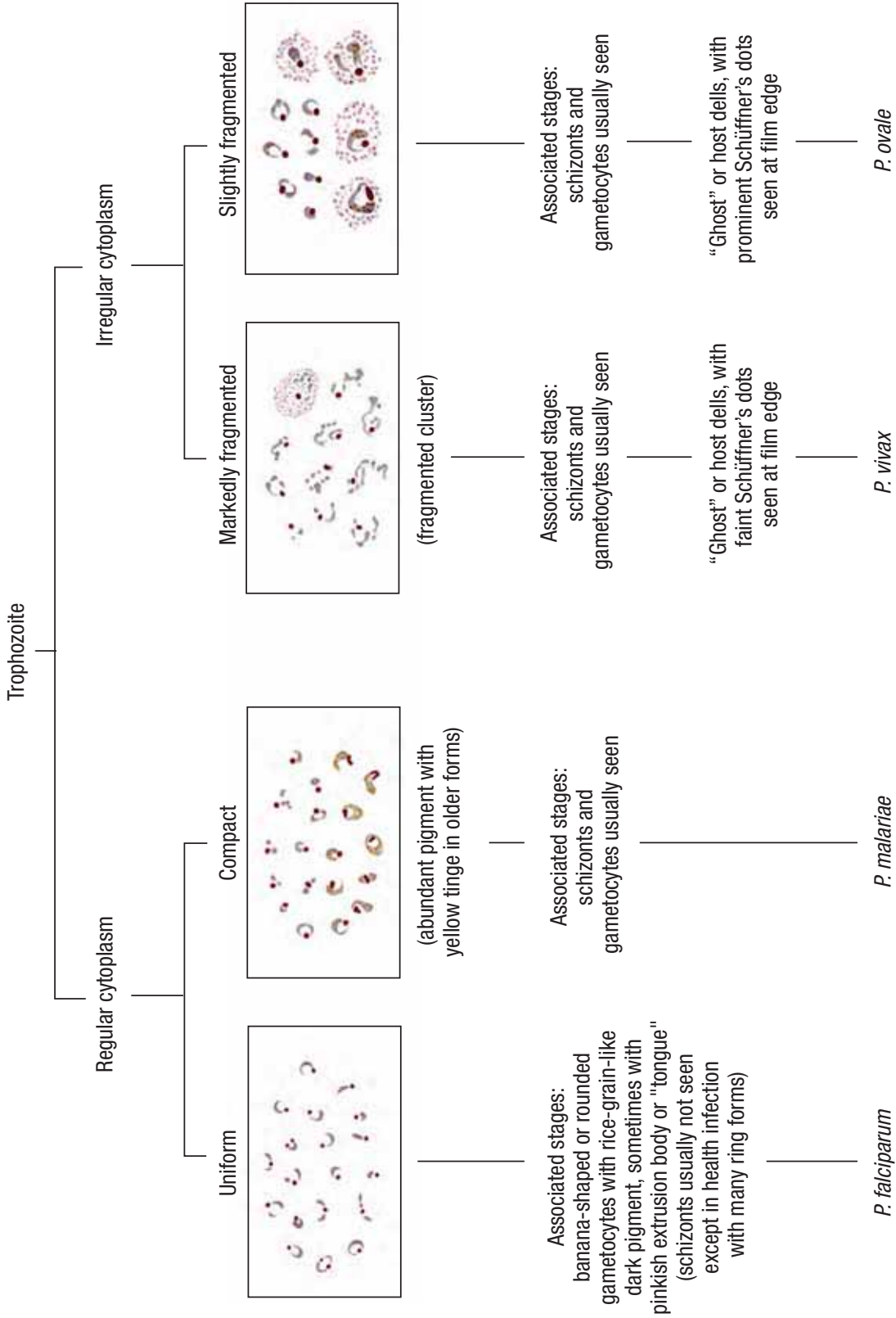

Malaria species differentiation in thick films based on patterns of cytoplasm and stippling in trophozoites (Giemsa stain)

Colour plates 4–7 of this handbook illustrate in line drawings the appearance of parasites, in thin films on the left side of each plate and in thick films on the right. Plate 8 gives a comparison of the different stages of each species in thick films. Use these, with the Bench aids, as your familiarity with the appearance of the different stages and species of malaria parasite increases. A series of microphotographs in the Bench aids show real parasite stages and species as they appear in thin and thick blood films.

When your facilitator considers you competent in the identification of stages and species in thin films, you will move to examination of parasites in thick blood films. The target level of competence in identification of species for peripheral level microscopists is 80%¹ (accuracy expected after review of a standard set of slides for accreditation). With practice, this is not difficult to achieve. As you gain in experience, you will easily reach the higher levels of competence that the course requires. It just takes practice and attention to detail.

Remember:

Identifying a positive slide as 'negative' is a misdiagnosis. It can mean that the diagnosis of malaria is missed and the patient is given the wrong treatment. If malaria was due to *P. falciparum*, the patient can become even more ill and may die.

Appearance of parasite species in thick blood films

Just as the appearance of red and white blood cells differs in thin and thick films, so too there are differences in the appearance of malaria parasites.

- No red blood cells are seen when the thick film is viewed with x100 oil immersion objective and paired x10 oculars.
- Malaria parasites can be clearly seen, although, like white blood cells, they appear smaller.
- The fine rings of the cytoplasm of some trophozoites appear to be incomplete or broken.
- The apparent absence of red blood cells makes Schüffner dots difficult to see, especially in the thicker parts of the film.
- The 'ghosts' of red cells can be seen surrounding parasites near the edge of the film. This will aid your diagnosis.
- The Maurer clefts of *P. falciparum* do not show up in stained thick films.

You will have to look carefully before you see parasites in a thick film, and you must use the fine adjustment to focus each time you look at an element or move the microscopic field. This is because the thick film is deeper than the single layer of cells in thin films. This practice of constantly focusing and refocusing should be-

¹ WHO. *Malaria microscopy quality assurance manual*. Manila, Western Pacific Regional Office, 2009.

come second nature as you gain experience in microscopy. If you do not constantly focus and refocus as you examine the field and move the slide, you run a real risk of 'missing' parasites.

Contaminants and artefacts in blood films

By now, you will have seen some objects in blood films that have caused confusion and uncertainty. There may be other blood parasites in your area, which are routinely collected in surveys or from patients. These non-malaria parasites should have been demonstrated to you. Although they are not artefacts, you must be familiar with them, as this is very important to the malaria control programme. This locally important subject will be explained in detail by your trainer.

Artefacts that appear regularly in blood films

Fungus

The best way to avoid fungal growth on slides is to ensure that cleaned, wrapped slides are stored in a dry place before use. In the hospital laboratory, slides are usually kept in methyl alcohol and then dried just before needed; therefore, the question seldom arises. In humid, warm climates, blood films that remain unstained for 48 h or more run a high risk for fungal contamination. Thick blood films that are not stained immediately should be dehaemoglobinized as soon as possible after they have dried. After they have been dehaemoglobinized and dried, they should be stored in a dry place until stained. This method does not guarantee freedom from fungal growth but does reduce the chance of it happening.

Airborne pollen and spores

These settle easily on newly made, still wet blood films, especially at certain times of the year and during surveys in village communities. If spores settle before the blood film is dry, they can take up the stain, causing even more confusion on examination. Drying blood films in a covered tray or slide box will help to avoid this kind of contamination.

Dirt and bacteria

Dirt or bacteria can be transferred from a patient's poorly cleaned finger when a blood film is made and when the slide for the film is not perfectly clean. Dirt from under fingernails is easily transferred to blood if it runs under the nail at the time of blood filming. Good personal hygiene by the patient and the use of protective latex gloves by the health worker will help prevent this problem.

Contaminated water

If water from wells, rainwater or rivers is used untreated to prepare buffered water or to rinse stain from slides, any organic contaminants present can be transferred to blood films, causing uncertain diagnoses. Boiling and filtering help eliminate this problem.

Plate 1. Plasmodium falciparum stages in Giemsa-stained thin and thick film

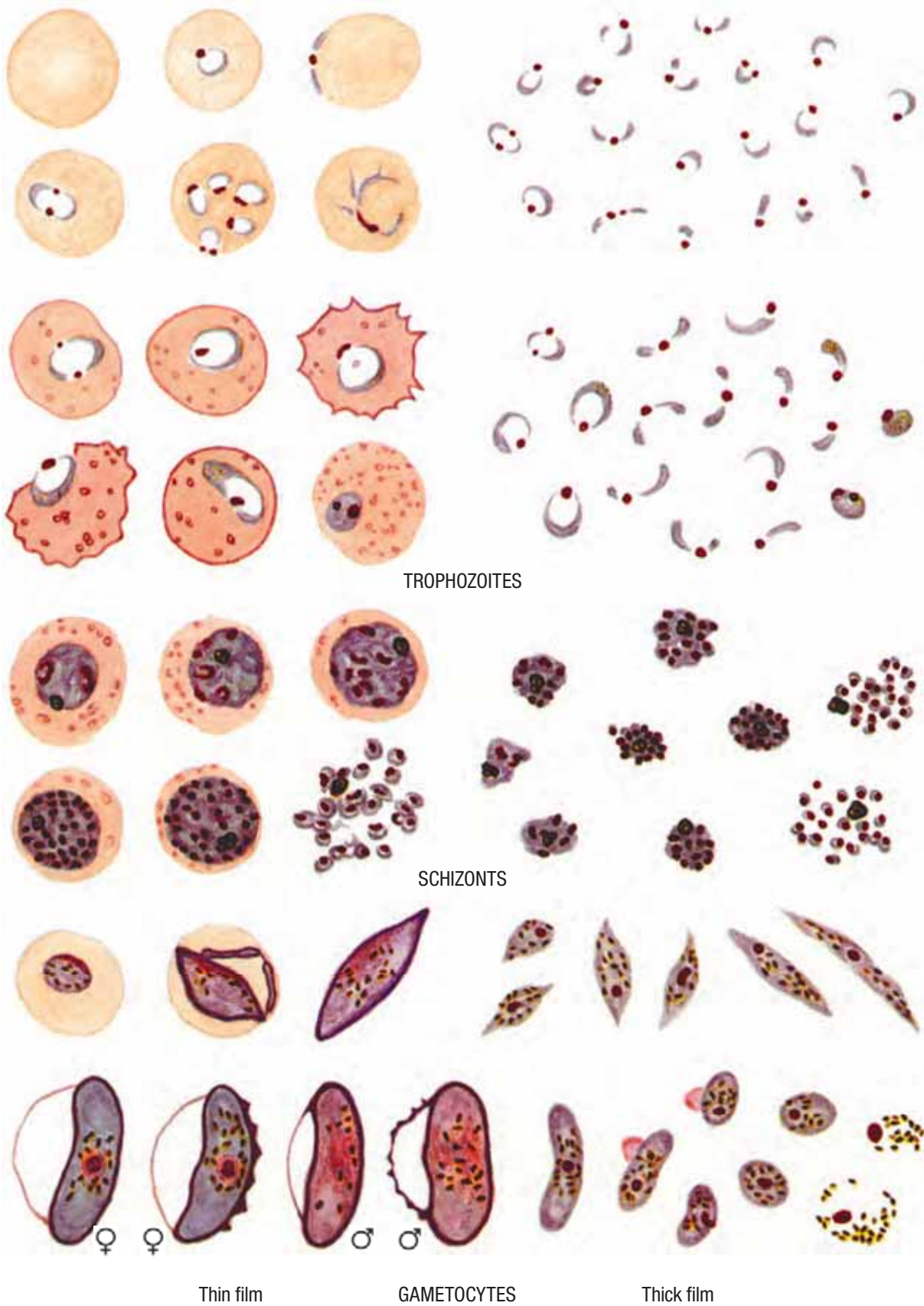

Plate 2. *Plasmodium vivax* stages in Giemsa-stained thin and thick blood films

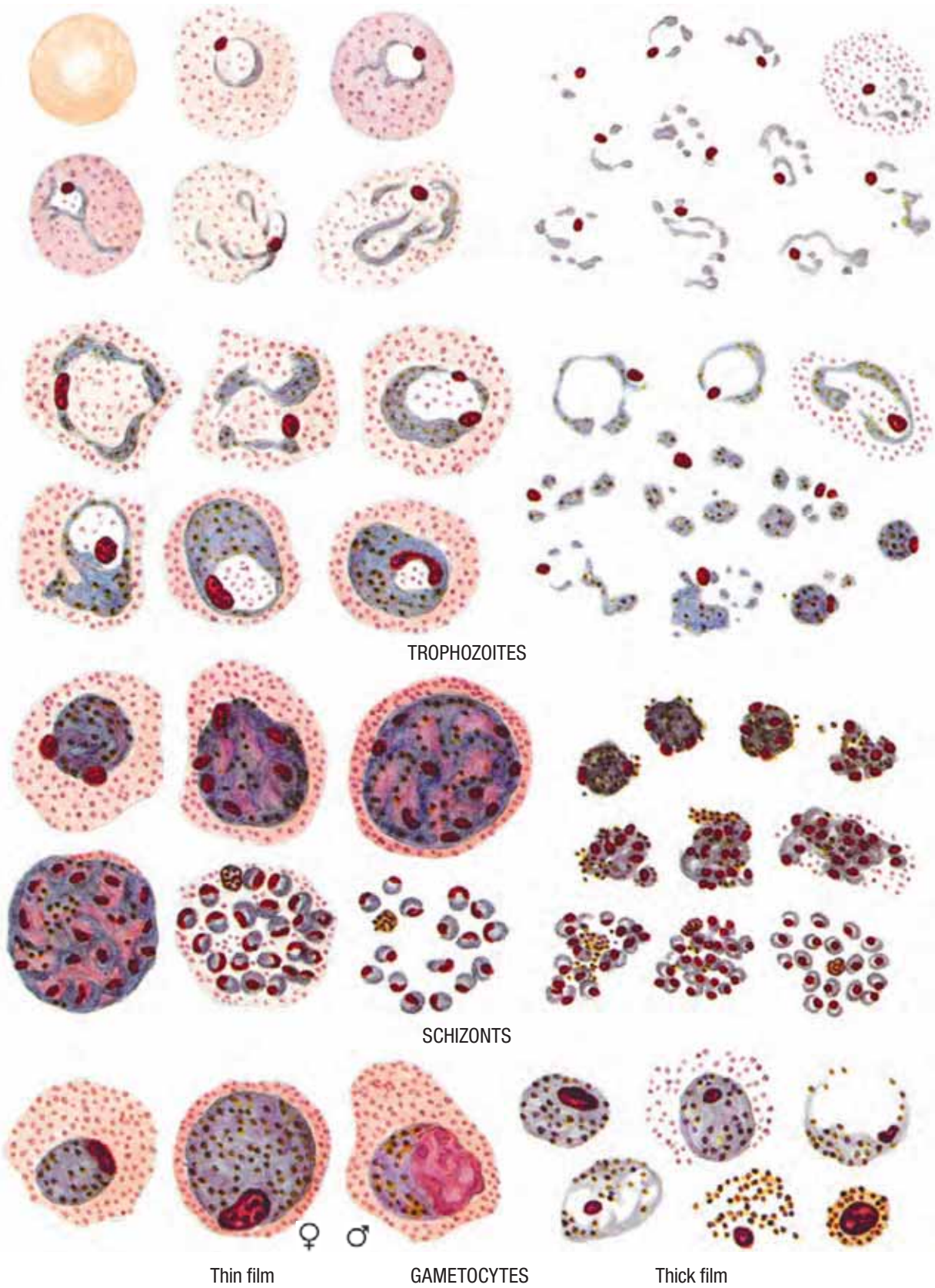

Plate 3. *Plasmodium malariae* stages in Giemsa-stained thin and thick films

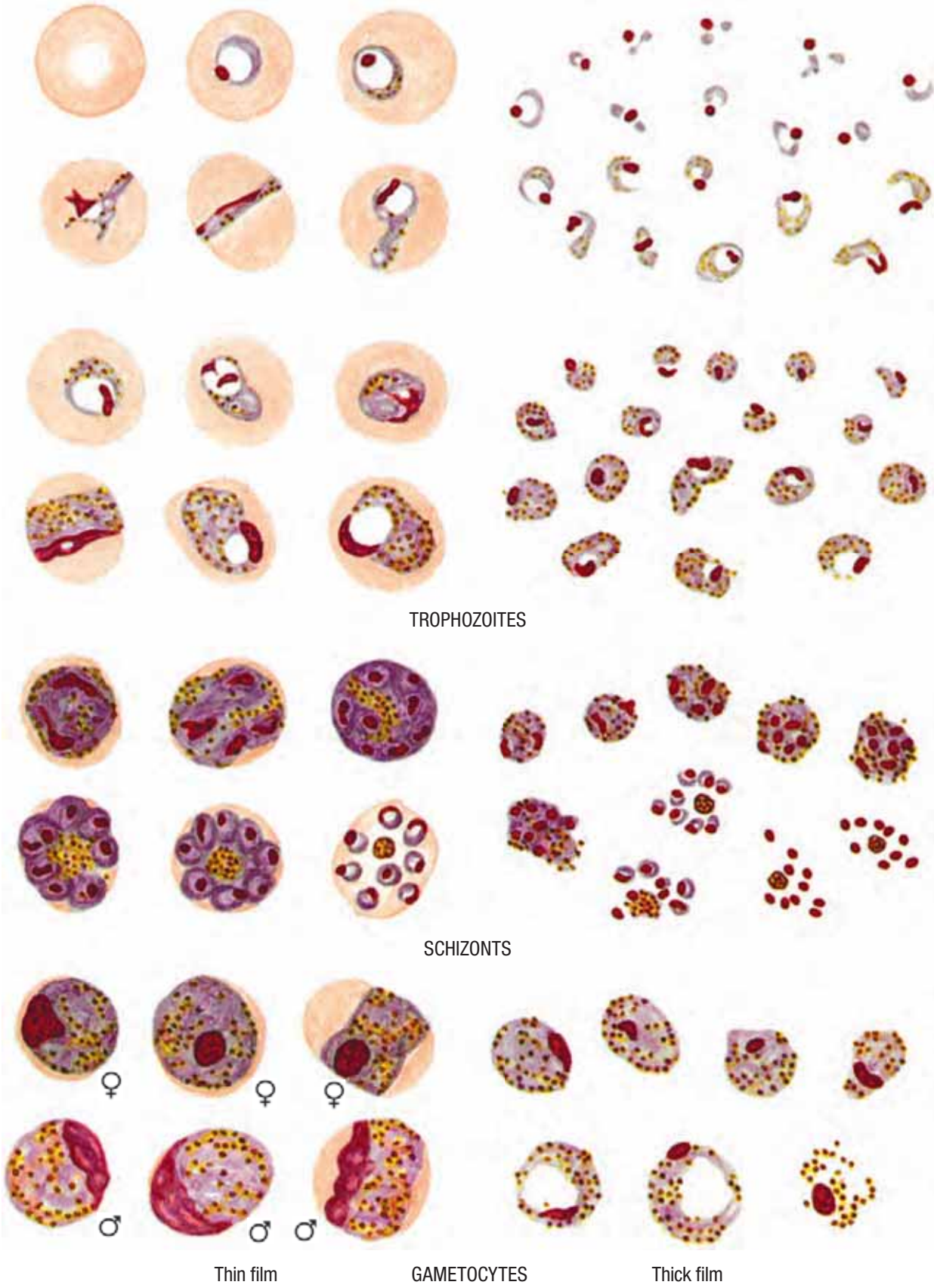

Plate 4. *Plasmodium ovale* stages in Giemsa-stained thin and thick films

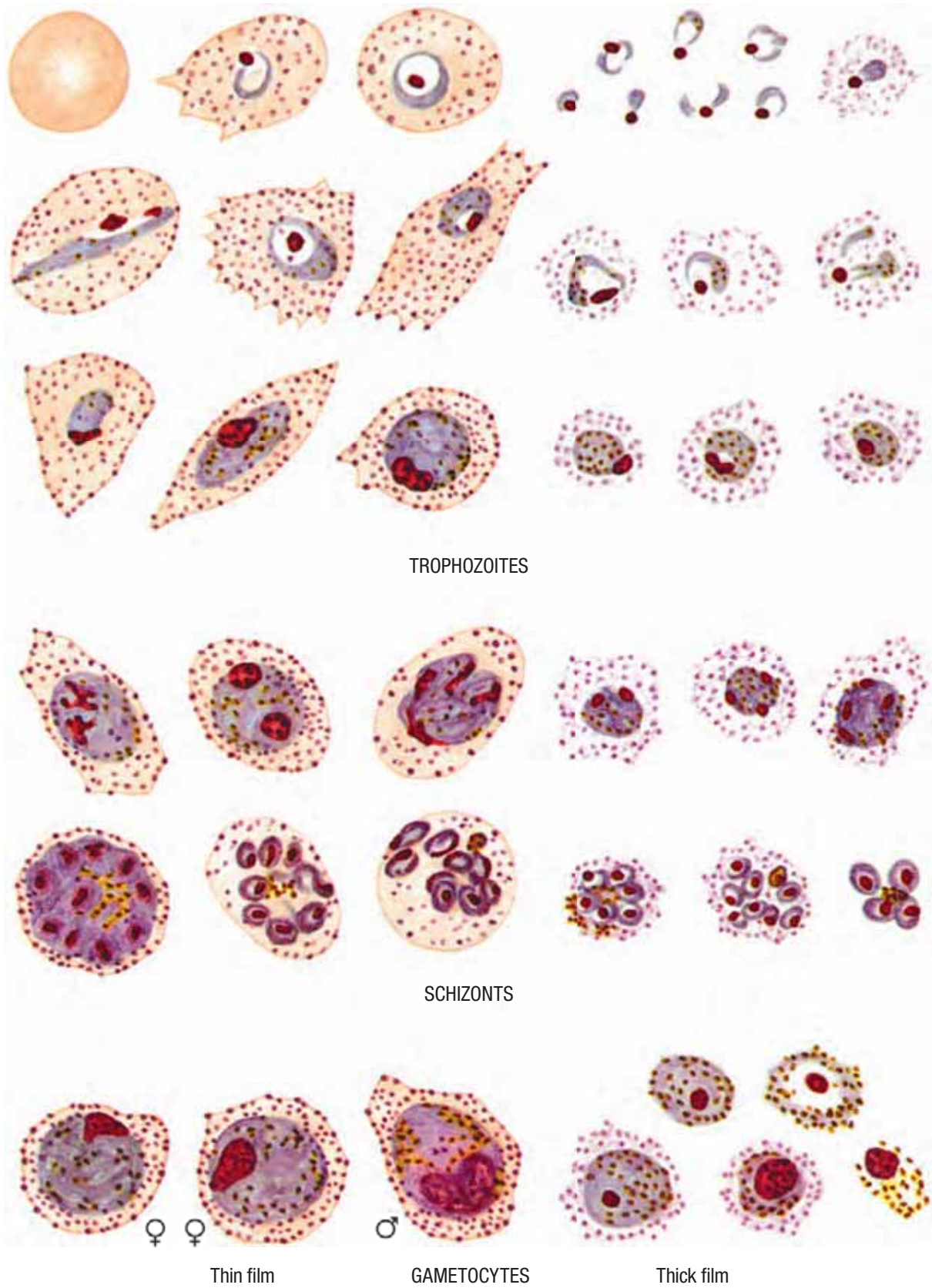
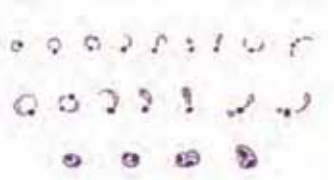



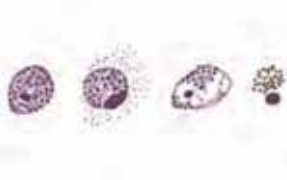

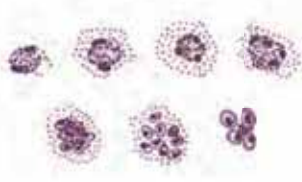

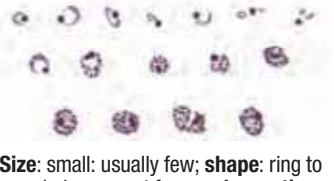
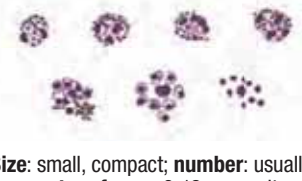
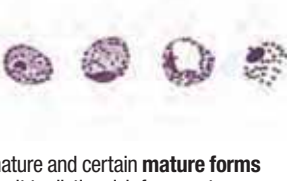

Plate 5. Species identification of malaria parasites in Giemsa-stained thick blood films

Species		Trophozoite	Schizont	Gametocyte
<i>Plasmodium falciparum</i>	Young, growing trophozoites and/or mature gametocytes usually seen	 <p>Size: small to medium; number: often numerous; shape: ring and comma forms common; chromatin: often two dots; cytoplasm: regular, fine to fleshy; mature forms: sometimes present in severe malaria, compact with pigment as few coarse grains or a mass</p>	 <p>Usually associated with many young ring forms. Size: small, compact; number: few, uncommon, usually in severe malaria; mature forms: 12-30 or more merozoites in compact cluster; pigment: single dark mass</p>	 <p>Immature pointed-end forms uncommon. mature forms: banana-shaped or rounded; chromatin: single, well defined; pigment: scattered, coarse, rice-grain-like; pink extrusion body sometimes present. Eroded forms with only chromatin and pigment often seen.</p>
	All stages seen; Schüffner stippling in 'ghost' of host red cells, especially at film edge	 <p>Size: small to large; number: few to moderate; shape: broken ring to irregular forms common; chromatin: single, occasionally two; cytoplasm: irregular or fragmented; mature forms: compact, dense; pigment: scattered, fine</p>	 <p>Size: large; number: few to moderate, mature forms: 12-24 merozoites, usually 16, in irregular cluster; pigment: loose mass</p>	 <p>Immature forms difficult to distinguish from mature trophozoites. mature forms: round, large; chromatin: single, well defined; pigment: scattered, fine. Eroded forms with scanty or no cytoplasm and only chromatin and pigment present.</p>
<i>Plasmodium ovale</i>	All stages seen; prominent Schüffner stippling in 'ghost' of host red cells, especially at film edge	 <p>Size: may be smaller than <i>P. vivax</i>; number: usually few; shape: ring to rounded, compact forms; chromatin: single, prominent; cytoplasm: fairly regular, fleshy; pigment: scattered, coarse.</p>	 <p>Immature forms difficult to distinguish from mature trophozoites. mature forms: round, may be smaller than <i>P. vivax</i>; chromatin: single, well defined; pigment: scattered, coarse. Eroded forms with only chromatin and pigment present.</p>	 <p>Size: rather like <i>P. malariae</i>; number: few; mature forms: 4-12 merozoites, usually 8, in loose cluster; pigment: concentrated mass.</p>
	All stages seen	 <p>Size: small: usually few; shape: ring to rounded, compact forms; chromatin: single, large; cytoplasm: regular, dense; pigment: scattered, abundant, with yellow tinge in older forms.</p>	 <p>Size: small, compact; number: usually few; mature forms: 6-12 merozoites, usually 8, in loose cluster, some apparently without cytoplasm; pigment: concentrated.</p>	 <p>Immature and certain mature forms difficult to distinguish from mature trophozoites. mature forms: round, compact; chromatin: single, well defined; pigment: scattered, coarse, may be peripherally distributed. Eroded forms with only chromatin and pigment present.</p>

Notes

Notes

Learning unit 9

Routine examination of blood films for malaria parasites

Learning objectives

By following the steps and standards in this Learning unit, you will be able when examining thick or thin blood films to:

- **demonstrate** consistency in Giemsa malaria microscopy;
- **demonstrate** competence and consistent accuracy in identifying malaria parasites;
- **demonstrate** competence and consistent accuracy in differentiating between *P. falciparum* and *P. vivax* infections;
- **explain** why thick films are routinely used for malaria diagnosis and any exceptions to this rule;
- **explain** why parasite counts are made and their use; and
- **demonstrate** consistency in counting malaria parasites in thick blood films and expressing them as parasites per microlitre of blood.

In this unit, you will use the routine slide examination methods for malaria parasites *that you will use when you return to your home laboratory*. This means following every step of the routine, including use of record forms and recording the results, as you have been taught.

As in the other learning units, reaching these objectives may seem difficult. You will find, however, that only the last two objectives are new. The others are no more than upgrades of previous objectives, which you will have already achieved to reach this point. Given practice and your present experience, these objectives will be reasonably easy to master.

Examining thick films

In Giemsa malaria microscopy, thick blood films are examined routinely. Provided the blood films are well made and correctly stained, the examination should be trouble-free. With continued practice, you will easily reach the levels of accuracy

required to demonstrate your competence in identifying malaria parasite stages and species. Giemsa microscopy is extremely sensitive, and an experienced examiner can detect malaria parasites at densities of 5–10 per microlitre of blood.

At this stage of the training, even though you may be able to differentiate easily between the stages of the four species, you will be expected to distinguish consistently only between *P. falciparum* and *P. vivax*, as these two species generally account for more than 95% of the total number of cases of malaria identified in most countries. Reaching the required level of competence requires concentrated practice and experience.

The commonest problem in identifying stage and species in thick films is differentiating between the early ring forms of the four species, particularly *P. vivax* and *P. falciparum*.









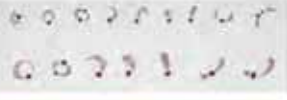
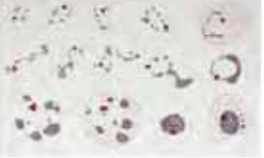

- Each species, on its own, is fairly easy to identify.
- With *P. vivax*, a range of trophozoite and schizont stages is usually present. The presence of Schüffner stippling combined with enlargement of the red blood cells confirms the diagnosis of *P. vivax*.
- *P. falciparum* usually has only young trophozoites, often in large numbers, and possibly the distinctive, mostly sausage-shaped gametocytes.
- Only in the most severe cases of falciparum malaria are mature trophozoites and schizont stages present in the thick film. Usually, they are hidden away in the deep organs of the body—called ‘sequestration’ (see Plate 1).
- If *P. vivax* stages are present with small rings and with no obvious Schüffner stippling or cellular enlargement, the slide must be identified as representing a mixed *P. vivax* and *P. falciparum* infection. The thin film should be examined to confirm this diagnosis.
- Be aware of the possibility that a second species (usually at a lower density) may be present in any positive film.
- *P. falciparum* rings remain small, with no obvious effect on the host red cell, apart from the presence of Maurer clefts in well-stained thin films.

In thick films, it is sometimes difficult to differentiate between:

- late or mature trophozoites and the gametocytes of *P. vivax*;
- *P. malariae* trophozoites and rounded *P. falciparum* gametocytes; and
- late trophozoites and the gametocytes of *P. malariae*.

In normal routine activity, recording whether gametocytes are present is confined to *P. falciparum*, which is usually an easy diagnosis.

Sequestration of malaria parasites.

	<i>P.falciparum</i>	<i>P.vivax</i>	<i>P.malariae</i>	<i>P.ovale</i>
Trophozoites				
Schizonts				
Gametocytes				

Sequestration: In *P.falciparum*, the parasite stages within the blue box are usually not seen in the peripheral blood except in heavy infections. With the other three species, all stages are seen in the peripheral blood. Parasites in thick films, Giemsa stained.

Technique for thick film microscopic examination**You will need:**

- a microscope fitted with paired x10, x40 and x100 objectives and a mechanical stage (an objective marker may be fitted if available);
- a mains-, battery- or solar-powered microscope lamp;
- slides;
- immersion oil;
- at least two tally counters, one for parasites and one for white blood cells;
- an electronic calculator;
- a laboratory timer;
- record forms; and
- a pen.

The method:

1. Place the slide to be examined on the stage, and position the thick film in line with the objective lens.
2. Place a drop of immersion oil on the thick film, and allow it to spread.
3. Using paired x10 oculars and a x40 objective, scan the film for microfilariae, other large blood parasites and obvious debris. Select the part of the film that is well stained, free of debris and has evenly distributed white blood cells.
4. Raise the revolving nosepiece away from the stage, and swivel the x100 oil immersion objective over the selected portion of the thick film.

5. Raise the mechanical stage until the objective lens gently touches the immersion oil.
6. Using the fine adjustment, focus on the cell elements and confirm that the portion of the film is acceptable for routine examination: 15–20 white blood cells per thick film field will give a satisfactory film thickness. Films with fewer white blood cells per field will require more extensive examination.
7. Starting at the X mark shown in the diagram below, examine the film carefully, field by field, moving to each contiguous field as in the pattern. For efficient examination, continuously focus and refocus using the fine adjustment throughout examination of each field.

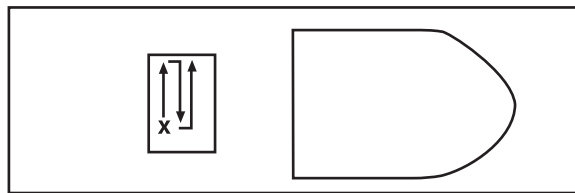

8. The number of fields examined routinely before the slide can be recorded as negative will vary by programme. Your facilitator will describe the system and national standard used in your country. Routine examination of a thick film is based on examination of 100 good fields; i.e. a slide can be pronounced negative only when a minimum of 100 fields have been carefully examined for the presence of parasites. If parasites are found but the diagnosis of species is uncertain, it is recommended that a further 100 fields be examined to identify a potential mixed infection.

Note: Examination of 100 oil immersion microscopic fields takes approximately 10 min.

9. If the slide is positive and the species has been identified, count the parasite density (see below), if it is part of your advised routine.
10. Finish the examination by recording your findings on the appropriate form(s).
11. Remove the immersion oil from the slide by the method used in your programme, and store the slide in a covered slide box for later reference.

Recording what you see

Different programmes and different individuals record the results of thick film examination in different ways. Unfortunately, there is no standardized way, which can lead to misunderstanding and confusion. When computer-coded records are used, brevity is essential, and the abbreviations may be unusual. Some common abbreviations for microscope observations are given below; your programme may have its own abbreviations.

Positive for malaria parasites: MP positive, MP

Negative for malaria parasites: MP negative, MP neg

Positive for <i>P. falciparum</i> :	Pf, PF, Pfal, F
Positive for <i>P. falciparum</i> gametocytes:	Pfg, PFG, FG
Positive for <i>P. vivax</i> :	Pv, PV, V
Positive for <i>P. malariae</i> :	Pm, PM, M
Positive for <i>P. ovale</i> :	Po, PO, O

Whatever abbreviations you are advised to use, please ensure that you use them consistently.

Examining the thin film

Thin films are not routinely examined to diagnose malaria in a patient, but there are exceptions to this rule. Examining a thin film is recommended when the thick film is too small, was lost during staining or became autofixed or unexamined for some other reason. Thin films may also be prepared when confirmation of the species is difficult or uncertain in the thick film and when the parasite density is very high.

Thin films are examined with a standard microscope.

The method:

1. Place the slide on the stage, siting the x100 oil immersion objective over the edge of the middle of the thin film, shown by the X mark on the diagram below.
2. Place a drop of immersion oil on the edge of the middle of the film.
3. Rack the mechanical stage up until the objective lens touches the immersion oil, as above.
4. Examine the blood film following the pattern of movement shown in the diagram, moving along the edge of the film, then moving the slide inwards by one field, returning in a lateral movement and so on.
5. Continue examining until the presence and species of malaria parasites have been identified, or up to at least 800 fields before declaring the slide negative.

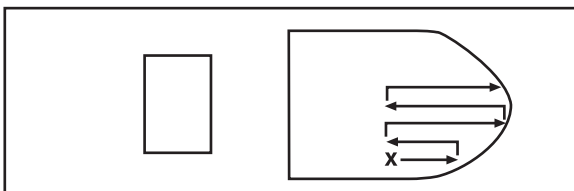

Note: To obtain the same sensitivity of examination as that for thick film at high power fields (with x100 oil immersion objective) for 10 min, you must examine a thin film for at least 30 min.

Parasite count

The parasite density of a positive blood film must be known because:

- The clinician needs to know the severity of the infection.
- The clinician needs to know how the infection is responding to treatment.
- Parasite counts are important in *P. falciparum* infections, which are always considered potentially dangerous.
- District health officers should be aware of the severity of the cases being observed in health facilities in their area.
- Determination of the density of infections may be required in cross-sectional and epidemiological investigations or in special studies, such as monitoring the therapeutic efficacy of antimalarial medicines.

The following method of establishing parasite density, which is reasonably and acceptably accurate, is recommended for its ease and simplicity. These steps are followed only after examination of the film is complete and the parasite stages and species established. The number of parasites is counted in relation to a standard number of leukocytes in the thick film. Although the most accurate count is obtained when the patient's true white cell count is known, this is usually not possible to ascertain in rural or remote areas. The number of leukocytes used (8000) is arbitrary, with wide variations among individuals, but the figure is accepted as reasonably accurate.

In addition to the materials already being used, you will need:

- two tally counters (one to count parasites and the other to count leukocytes) and
- a simple electronic calculator.

The method:

1. Count the number of parasites seen on one tally counter and the number of white blood cells on the other, oil immersion field by field.
2. The number of parasites and white blood cells counted depends on how numerous the parasites are and the time you have available to make the count. The lower the number of parasites counted, the higher the number of white blood cells that should be counted. If, after 200 white blood cells have been counted, 100 or more parasites are found, the results should be recorded on the form in terms of number of parasites per 200 white blood cells. If, after 200 white blood cells have been counted, the number of parasites is 99 or fewer,

counting should be continued up to 500 white blood cells. Some parasitaemias are so heavy that hundreds of parasites are counted per oil immersion field. In this situation, counting up to 100 white blood cells or the total number in about five oil-immersion fields (assuming about 15 white blood cells per thick-film field) would be appropriate.

- When counting is completed, the number of parasites relative to the number of leukocytes is calculated and expressed as 'parasites per microlitre of blood' from the simple mathematical formula:

$$\frac{\text{Number of parasites counted} \times 8000}{\text{Number of leukocytes}} = \text{parasites per microlitre}$$

In mixed infections (two species or more), it is usual to count all asexual parasites together and to express the result as, for example: *P. falciparum* + *P. vivax* = 23 720 μ l (593 parasites counted against 200 white blood cells x 8000). Some programmes require a count of *P. falciparum* gametocytes when present, and this may be important in studies of the response of the gametocytes to primaquine. You may be instructed to do so, using an additional tally counter, within your programme.

The 'plus system' is an old method, which is simple but far less accurate for establishing parasite density in thick blood films. Because of its unreliability, it has been replaced by the method described above and is no longer recommended. Its use persists in places where the quantitative method cannot be used. Studies have shown that many workers forget the finer details of the system and mix up the code (the number of plus signs) and the count (the number of parasites per field or per 100 fields), resulting in unreliable information on parasite density. In this system,

- + = 1–10 parasites per 100 oil-immersion thick film fields
- ++ = 11–100 parasites per 100 oil-immersion thick film fields
- +++ = 1–10 parasites per single oil-immersion thick film field
- ++++ = more than 10 parasites per single oil-immersion thick film field

**Read Learning unit 10 in the run-up
to your graduation.**

Notes

Learning unit 10

Supervisory aspects of malaria microscopy

Lesson objectives

By the end of this Learning unit, you will be able to:

-
- **explain** the importance of supervision to your work;
 - **explain** the ways in which your work will be supervised; and
 - **describe** what you must provide for your supervisor to effectively supervise your work.
-

Graduating from this training in Giemsa microscopy means you have reached the required levels of efficiency and competence. You can expect to work with patients who rely on your skills and knowledge to establish whether they have malaria. You have learnt that there is little room for error when dealing with patients, which is why your levels of achieved technical competence and accuracy were targeted at 80% or over. After graduation, it is important to ensure you continue to maintain the standards reached during training. To do this, your supervisor will regularly monitor your work, as well as continuing to help improve your skills and competence. This is called quality control and is part of the overall quality assurance activities that are operated throughout malaria microscopy services.

Remember, regular supervision of your work is necessary to:

- confirm that you continue to do your job as you were trained;
- ensure the continuity of the high levels of service and reliability that your laboratory provides to the public;
- help you adjust your work and work routine as your supervisor advises;
- identify when advanced training would be of benefit to you or when you might profit from a short re-training course;
- provide opportunities to discuss and solve local problems;
- provide evidence of personal performance achievements; and
- help identify staff suitable for career advancement.

Types of supervision

There are two types of supervision, direct and indirect.

Direct supervision

In direct supervision, your supervisor is in touch with you, either when visiting or during a longer period if you both work in the same place. In this way, the supervisor can observe what you do in your work, how you do it, whether you need to modify some activities and whether you have a shortage of supplies or materials. This provides a useful opportunity to discuss important matters that might be difficult to communicate by letter, telephone or e-mail. Unless the two people are working in the same place or fairly close by, this kind of supervision is difficult to carry out regularly and may be expensive in manpower, time and money. The approach is, however, important for assessing multiple factors that are beyond the competence of the microscopist but which influence his or her performance, such as the status of equipment, workload and working environment.

Visitors' book:

Health establishments keep a record of visiting supervisory and specialist staff in a visitors' book, in which are recorded the date, work or inspection carried out and other comments considered appropriate. It is a valuable aid to your work. You will receive a sample to take home, if your laboratory does not already have one.

Indirect supervision

Indirect supervision involves assessment of a person's work from regularly submitted data and other information. Of greatest interest to a supervisor is the condition of submitted blood films. Are they up to the established standard? How accurate is the diagnosis when compared with the supervisor's re-examination (cross-checking)? Such quality assurance is important to the microscopist and the programme. This activity is based on a standard, internationally accepted approach: supervisors follow a series of fixed steps, with established standards to measure your performance and the performance of every other microscopist in the service, including that of the supervisor.

In this arrangement, supervisors can assess and monitor from a distance the standard and quality of your blood films (thin and thick), the staining, the results of thick blood film examinations, stage and species diagnosis and, where required, parasite density counts.

The method of cross-checking the results of malaria slide examinations may vary slightly between countries, but the general outcome is about the same: 10% of all positive and negative slides are re-examined by other skilled microscopists who are unaware of ('blinded to') your results. WHO recommends that 10 slides be cross-checked each month and that they be randomly selected as five negative slides and five positive with low parasite density (20–200 parasites per microlitre).

Selecting slides randomly for cross-checking is not difficult, but the choice does not rest with the original examiner. The commonest method is that, at the end of the month, you are told the last digit of the serially numbered slides that you are to select and send for re-examination. For example, all slides ending with the number 5 are to be selected. If a slide ending in 5 is missing, you select either one down, 4, or one up, 6. You should then wrap the slides carefully in clean paper, pack them and forward them to the supervisor.

The slides are re-examined 'blind', and the two results for that slide are compared. Then, any differences or discrepancies are identified, the records corrected and the feedback forwarded to the original examiner.

As the original examiner, you should not re-examine the selected slides yourself before sending them to the supervisor—just to make sure that your original diagnosis was correct! Such a practice is unprofessional and would soon be discovered from unusual corrections in laboratory records or delays in submitting your work.

This system works well when you are confident enough to submit your examined slides to others, knowing that you have kept to the established methods and that your standards remain high. With that attitude, this kind of supervision can only be supportive and welcomed by you.

The system is of little value, however, unless the original microscopist receives regular feedback on the re-examined slides. When the re-examined material is sent back, you can see where you have gone wrong. This has an even better impact when the supervisor can show you what the discrepancies are and explain and discuss the corrected diagnosis.

Supervision, quality assurance and quality control, because of their importance, are under constant review, and your programme may be introducing a revised system. Your tutor and facilitator will discuss with you the current system in use in your country and how it applies to you.

You are about to return home.

You are now a qualified malaria microscopist, with the certificate or certified logbook to prove it. You have mastered a difficult subject but are a little nervous of working alone. You will not be alone, as this Learner's guide and the other materials you received are for your reference and will continue to help you in your daily work.

Remember, your job is important for patients' well-being, which relies on your high standards of competence. Your supervisor may be far away, but always inform him or her of any problems as soon as possible. Supervisors are there to help resolve difficulties that arise, but they will be unable to help if they do not know of them.

Notes

Further reading

Bench Aids for Malaria Microscopy.

Geneva, World health Organization, 2010

Diagnosis of malaria.

Lopez-Antuñano FJ, Schmunis G, eds.

Washington, DC, Pan American Health Organization, 1990 (PAHO Scientific Publications, No. 512).

Laboratory biosafety manual, 3rd ed.

Geneva, World Health Organization, 2004.

Malaria Microscopy Quality Assurance Manual

World Health Organization, Regional Office for the Western Pacific, 2009

Malaria: principles and practice of malariology. Vol. 1. Vol. 2.

Wernsdorfer WH, McGregor I, eds.

Edinburgh, Churchill Livingstone, 1988.

Microscopists are vital to malaria programmes, and their diagnostic and technical skills are relied on in both curative services and disease surveillance. Thus, training in malaria microscopy must be sound and must reach today's high standards. This training package has been adjusted to meet the changes in the way malaria is diagnosed and treated. The training manual is divided in two parts: a learner's guide (Part I) and a tutor's guide (Part II). The package includes a CD-ROM, prepared by the United States Centers for Disease Control and Prevention, which contains microphotographs of the different malaria parasite species and technical information in PowerPoint format, which can be shown during training sessions and referred to by the participants. Emphasis is placed on teaching and learning, including monitoring and evaluating individuals and the group during training.

The Learner's guide (*Basic Malaria Microscopy*, Part I) will assist participants during training in the microscopic diagnosis of human malaria. Designed as the foundation for formal training of 4-5 weeks duration, the guide is destined for participants with only elementary knowledge of science.

ISBN 978 92 4 154782 6

